

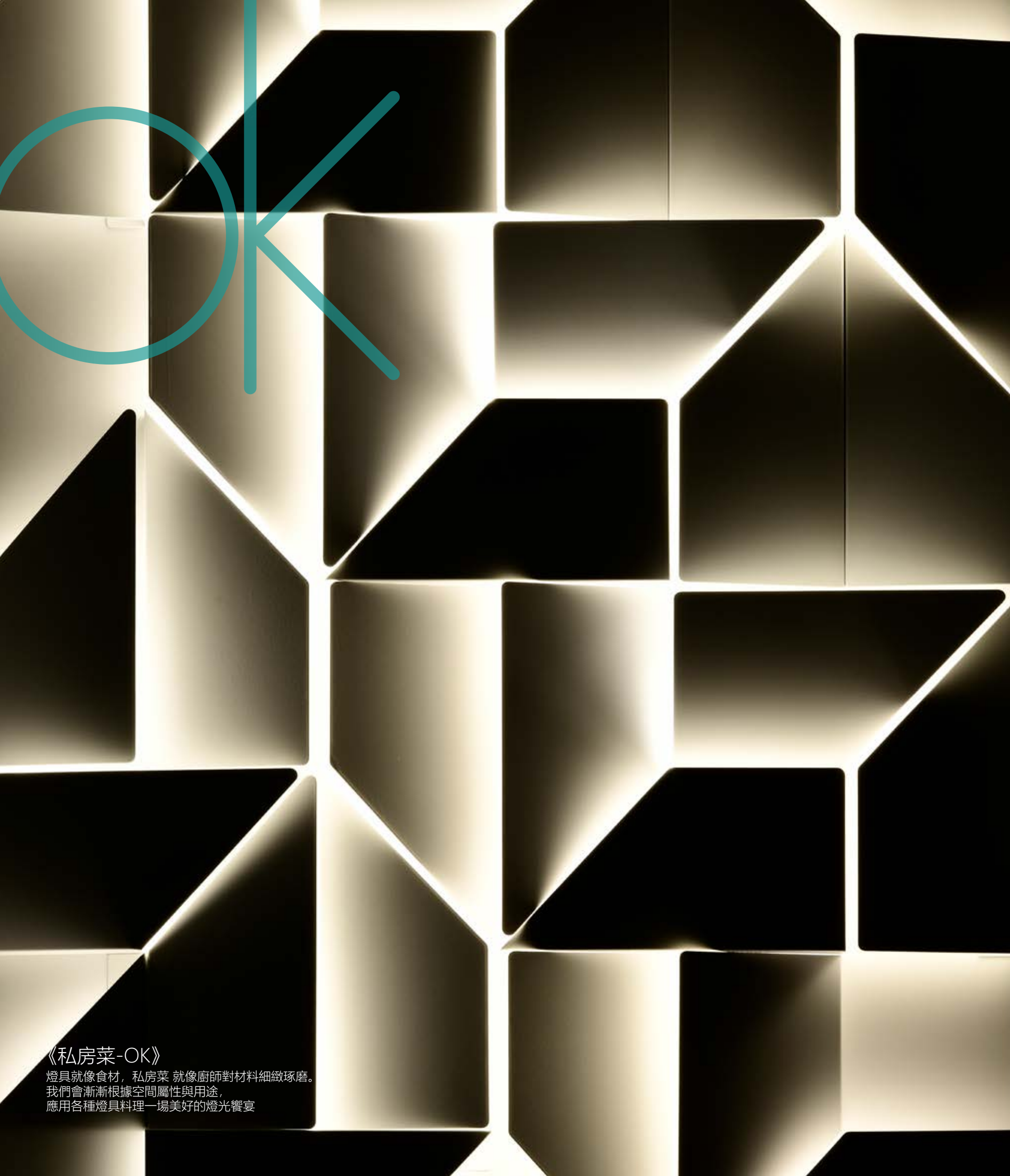

OK

LED CATALOGUE





H1000

W700

OK 20011 164300

W700 H1000mm

內附LED 56W 3000K

鋼材

附遙控無極調光明暗

《私房菜-OK》

燈具就像食材，私房菜 就像廚師對材料細緻琢磨。
我們會漸漸根據空間屬性與用途，
應用各種燈具料理一場美好的燈光饗宴

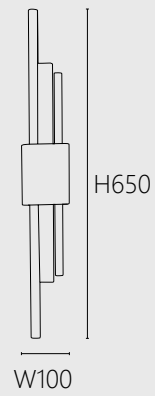

OK 20021 38000
W100 H650mm
內附LED 3W x2 3000K
大理石 鋼材

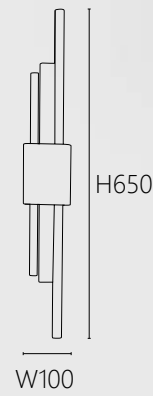

OK 20022 38000
W100 H650mm
內附LED 3W x2 3000K
大理石 鋼材

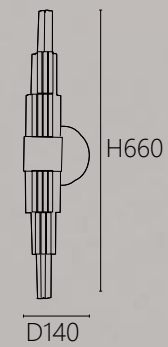
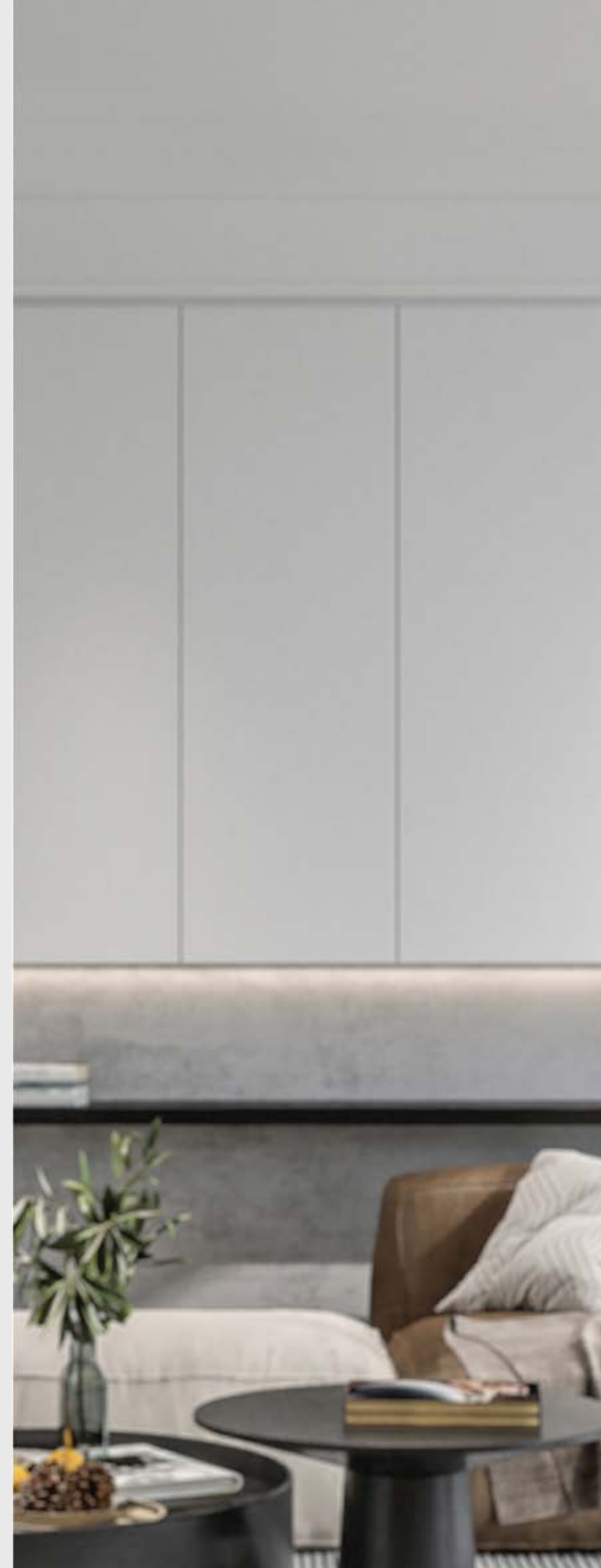

OK 20031 59500
H660 D140mm
附G9 x2 3000K
鋼材



OK 20041 20000
 W220 H600 D110mm
 E14 x 2另計
 鋼材 水晶玻璃

OK 20042 20000
 W220 H600 D110mm
 E14 x 2另計
 鋼材 水晶玻璃



OK 20051



OK 20052

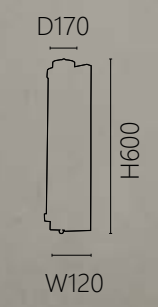

OK 20051/2 22000
 W120 H600 D170mm
 E14 x 2另計
 鋼材 水晶玻璃





OK 20061 OK 20062



OK 20063 OK 20064

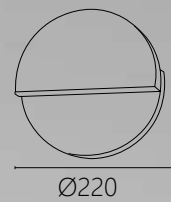

OK 20061/2 18000
 Ø220 D60mm
 內附LED 10W 3000K
 鋼材 壓克力
 可旋轉350°

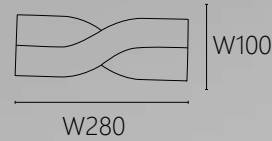

OK 20063/4 15000
 L280 W100 D70mm
 內附LED 6W 3000K
 鋼材 壓克力
 可旋轉350°



OK 20071 OK 20072



OK 20073 OK 20074

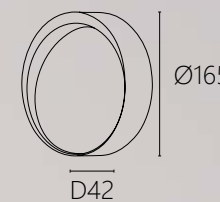

OK 20071/2 18000
 Ø165 D42mm
 內附LED 6W 3000K
 鋁材烤漆

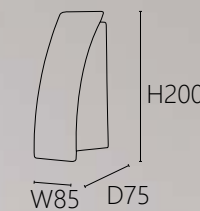

OK 20073/4 17500
 W85 H200 D75mm
 內附LED 6W 3000K
 鋁材烤漆



OK 20081

OK 20083

OK 20082

OK 20084

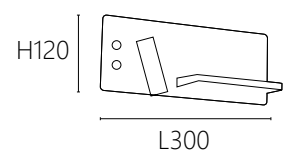

OK 20081 26000
L300 D110 H120mm
內含LED 3W x 1 / 5W x 1 3000K
鋼材烤漆
可無線充電

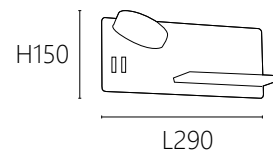

OK 20082 26000
L290 D110 H150mm
內含LED 5W 3000K
鋼材烤漆
可無線充電

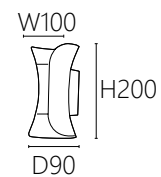

OK 20083/4 12800
W100 H200 D90mm
附LED 3W x 2 3000K
鋁材烤漆



OK 20091B/W

OK 20092B/W

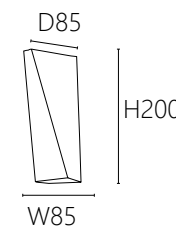

OK 20091B/W 16000
W85 H200 D85mm
附LED 3W x 2 3000K
鋁材烤漆

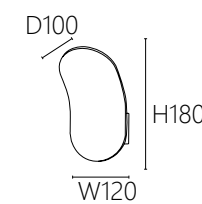

OK 20092B/W 12500
W120 H180 D100mm
內附LED 6W 3000K
鋁材烤漆



OK 20101



OK 20102

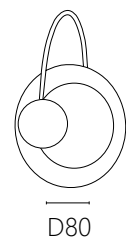

Ø280

D80

OK 20101/2 18000
Ø280 D80mm
G9 x 1另計
鋼材
可隨意調整軟管

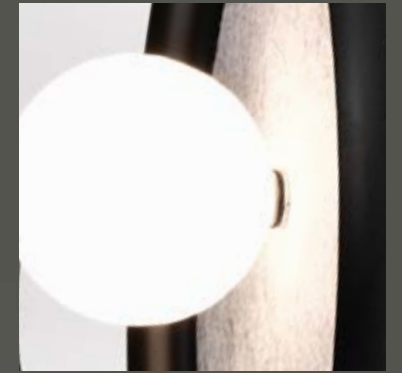

(磁吸球體可調整)



OK 20111



OK 20112



Ø250

D95

OK 20111/2 20000
Ø250 D95mm
G9 x 1另計
鋼材
磁吸球體可調整



OK 20121



OK 20122

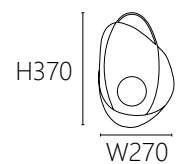

OK 20121/2 19000
W270 H370mm
內附LED 5W x 1 3000K
仿石材 鋼材

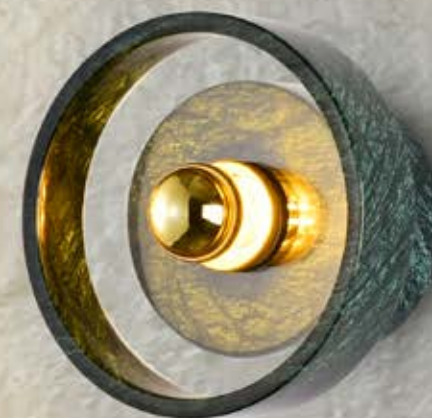

OK 20132



OK 20131

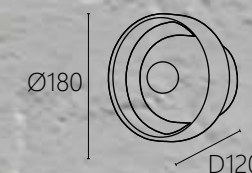

OK 20131/2 32000
Ø180 D120mm
附LED 4W x 1 3000K
大理石

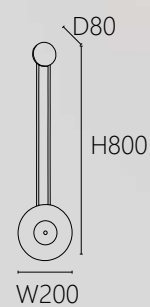

OK 20141 52000
W200 H800 D80mm
內附LED 6W 3000K
水晶砂玻璃 鋼材

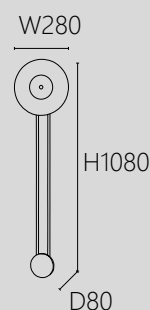

OK 20142 60000
W280 H1080 D80mm
內附LED 6W 3000K
水晶砂玻璃 鋼材

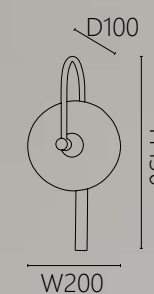

OK 20151 35000
W200 H430 D100mm
內附LED 6W 3000K
水晶砂玻璃 鋼材



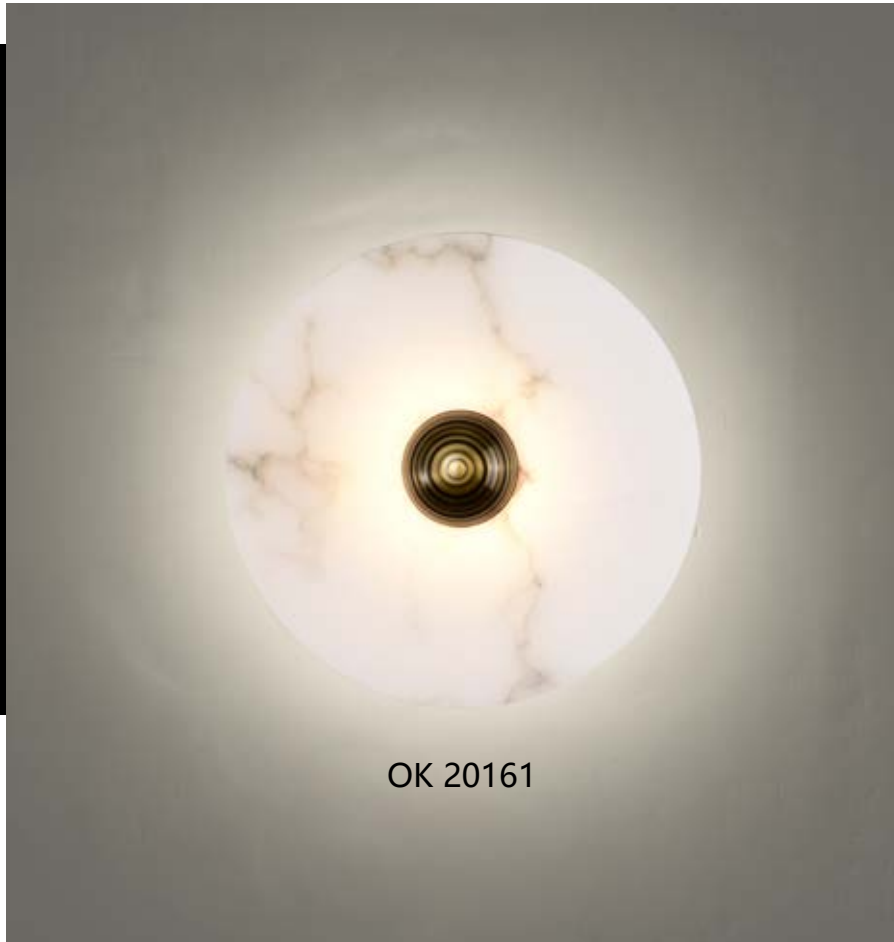

OK 20161



OK 20162

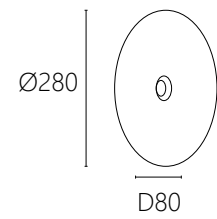

OK 20161 45000
 Ø280 D80mm
 內附LED 6W 3000K
 雲石 鋁材

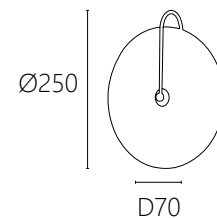

OK 20162 33000
 Ø250 D70mm
 內附LED 6W 3000K
 雲石 鋼材

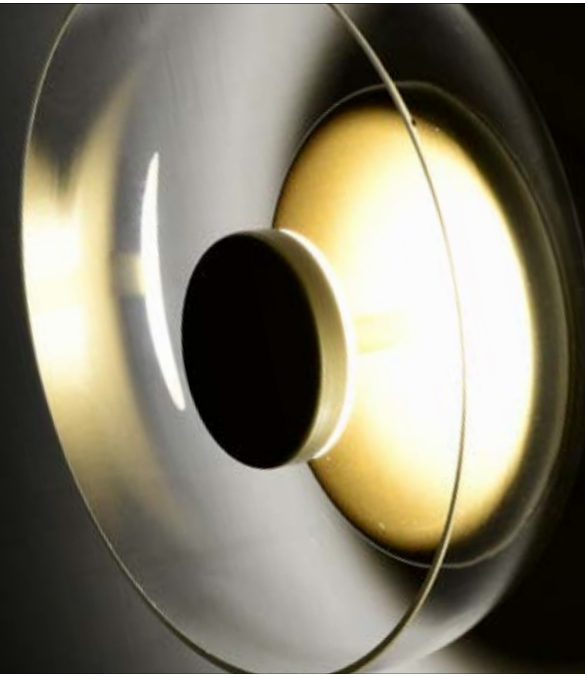

OK 20171



OK 20172

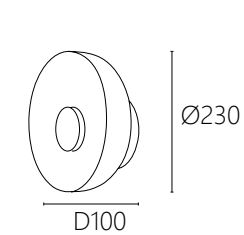

OK 20171 25000
 Ø230 D100mm
 內附LED 5W 3000K
 鋼材

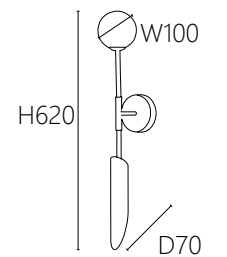

OK 20172 28000
 W100 H620 D120mm
 G9 x 2另計
 鋼材

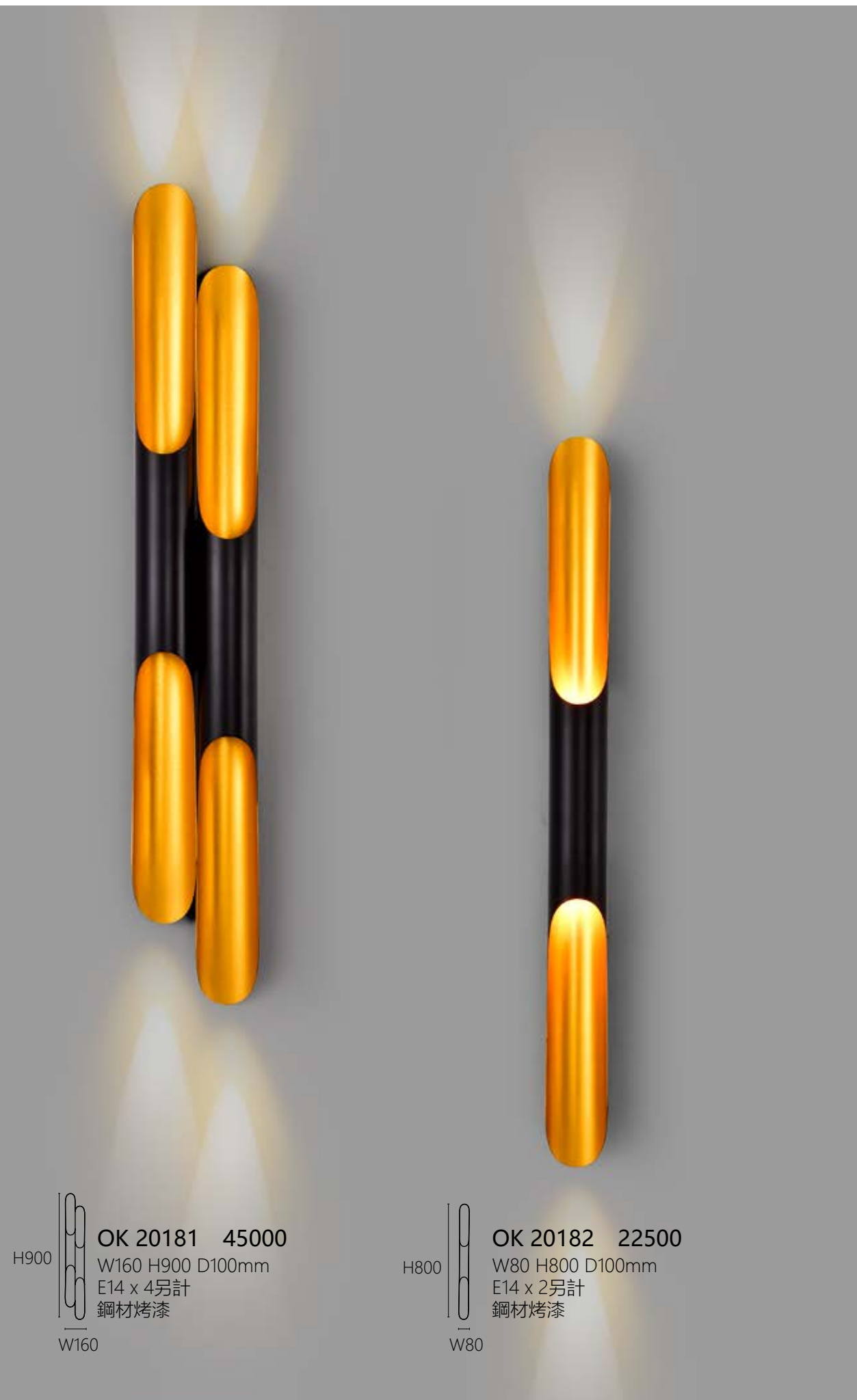



OK 20211



背部結構

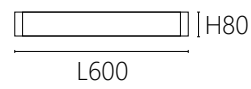

OK 20201 21000
 L600 H80 D30mm
 附LED 9W x 2 3000K
 鋁材烤漆

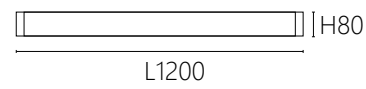

OK 20202 33000
 L1200 H80 D30mm
 附LED 18W x 2 3000K
 鋁材烤漆

OK 20212

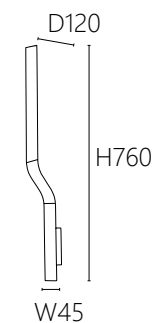

OK 20211/2 26000
 W45 H760 D120mm
 內附LED 5W 3000K
 鋁材



OK 20221



OK 20222

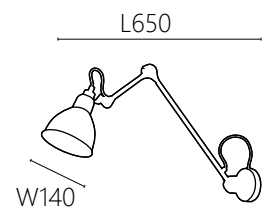

OK 20221/2 32000
 W140 L650mm
 E14 x 1另計
 鋼材烤漆



OK 20231

OK 20232

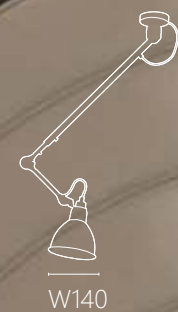

OK 20231/2 44000
 W140 H585~955mm
 E14 x 1另計
 鋼材烤漆 可伸縮式

024



OK 20241 36000
L1200 D100mm
附LED 15W 3000K
鋼材

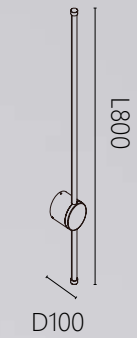

OK 20242 23000
L800 D100mm
附LED 10W 3000K
鋼材

025

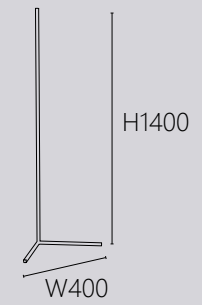

OK 20251 42000
W400 H1400mm
附LED 18W 3000K
鋼材



OK 20261



OK 20262

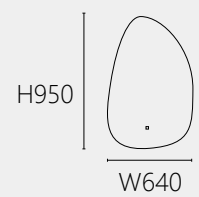

OK 20261 66000
W640 H950 D35mm
內附LED 20W 三段式變光
觸控式開關 線長1000mm
玻璃 鋼材

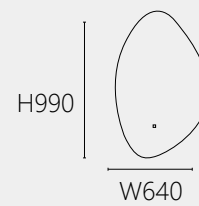

OK 10262 66000
W640 H990 D35mm
內附LED 20W 三段式變光
觸控式開關 線長1000mm
玻璃 鋼材

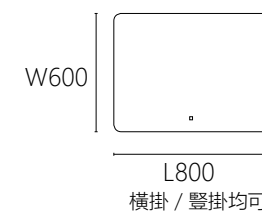

OK 20271 58000
L800 W600 D35mm
內附LED 25W 三段式變光
觸控式開關 線長1000mm
玻璃 鋼材

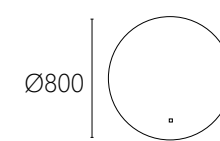

OK 20272 58000
Ø800 D35mm
內附LED 23W 三段式變光
觸控式開關 線長1000mm
玻璃 鋼材

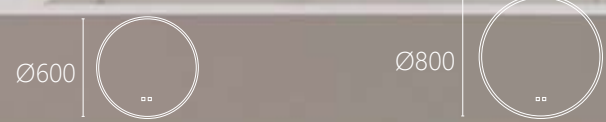

OK 20281 68000

Ø600 D35mm
內附LED 15W 三段式變光
觸控式開關 線長1000mm
玻璃 鋼材
除霧功能

OK 20282 79000

Ø800 D35mm
內附LED 25W 三段式變光
觸控式開關 線長1000mm
玻璃 鋼材
除霧功能

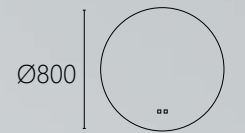

OK 20291 72000

Ø800 D35mm
內附LED 23W 三段式變光
觸控式開關 線長1000mm
玻璃 鋼材
附除霧功能

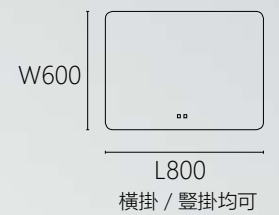

OK 20292 72000

L800 W600 D35mm
內附LED 25W 三段式變光
觸控式開關 線長1000mm
玻璃 鋼材
附除霧功能



全包覆皮革

OK 20301

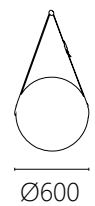

OK 20301 68000
 Ø600 D35m
 內附LED 15W 三段式變光
 觸控式開關
 鋼材 玻璃 皮革



OK 20302

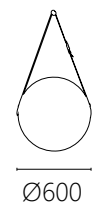

OK 20302 56000
 Ø600 D30m
 內附LED 15W 三段式變光
 觸控式開關
 鋼材 玻璃 皮革



OK 20311

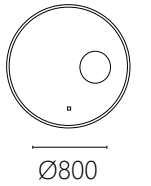

OK 20311 78000
 Ø800 D35mm
 內附LED 25W 三段式變光
 觸控式開關 線長1000mm
 玻璃 鋼材



OK 20312

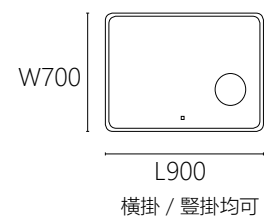

OK 20312 78000
 L900 W700 D35mm
 內附LED 28W 三段式變光
 觸控式開關 線長1000mm
 玻璃 鋼材





OK 20321 96000
 Ø600 H160mm 線長1000mm
 G9 x 12另計
 鋼材電鍍 玻璃

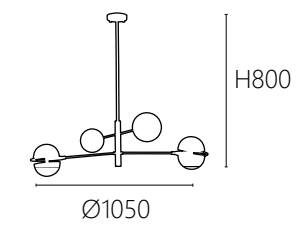

OK 20331 72000
 Ø1050 H800mm
 G9 x 4另計/E14 x 2另計
 鋼材電鍍 玻璃
 桿長250+250mm

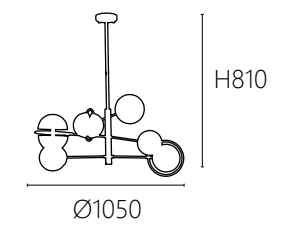

OK 20332 92000
 Ø1050 H810mm
 G9 x 6另計/E14 x 3另計
 鋼材電鍍 玻璃
 桿長250+250mm

034



OK 20341 105000
Ø600 H270mm
附LED 6W x 12 4000K
鋼材+鋁材電鍍 壓克力
線長1500mm

035

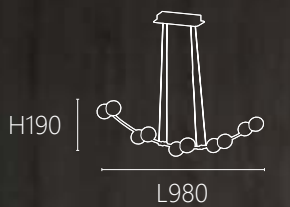

OK 20351 94000
L980 W270 H190mm
附LED 6W x 10 4000K
鋼材+鋁材電鍍 壓克力
線長1500mm

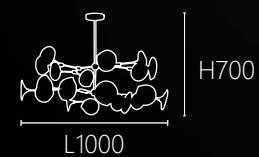

OK 20361 157000
 L1000 W1000 H700mm
 G4 x 20另計
 鋼材電鍍 玻璃
 桿長300mm

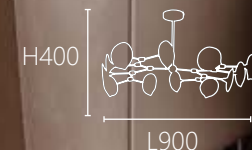
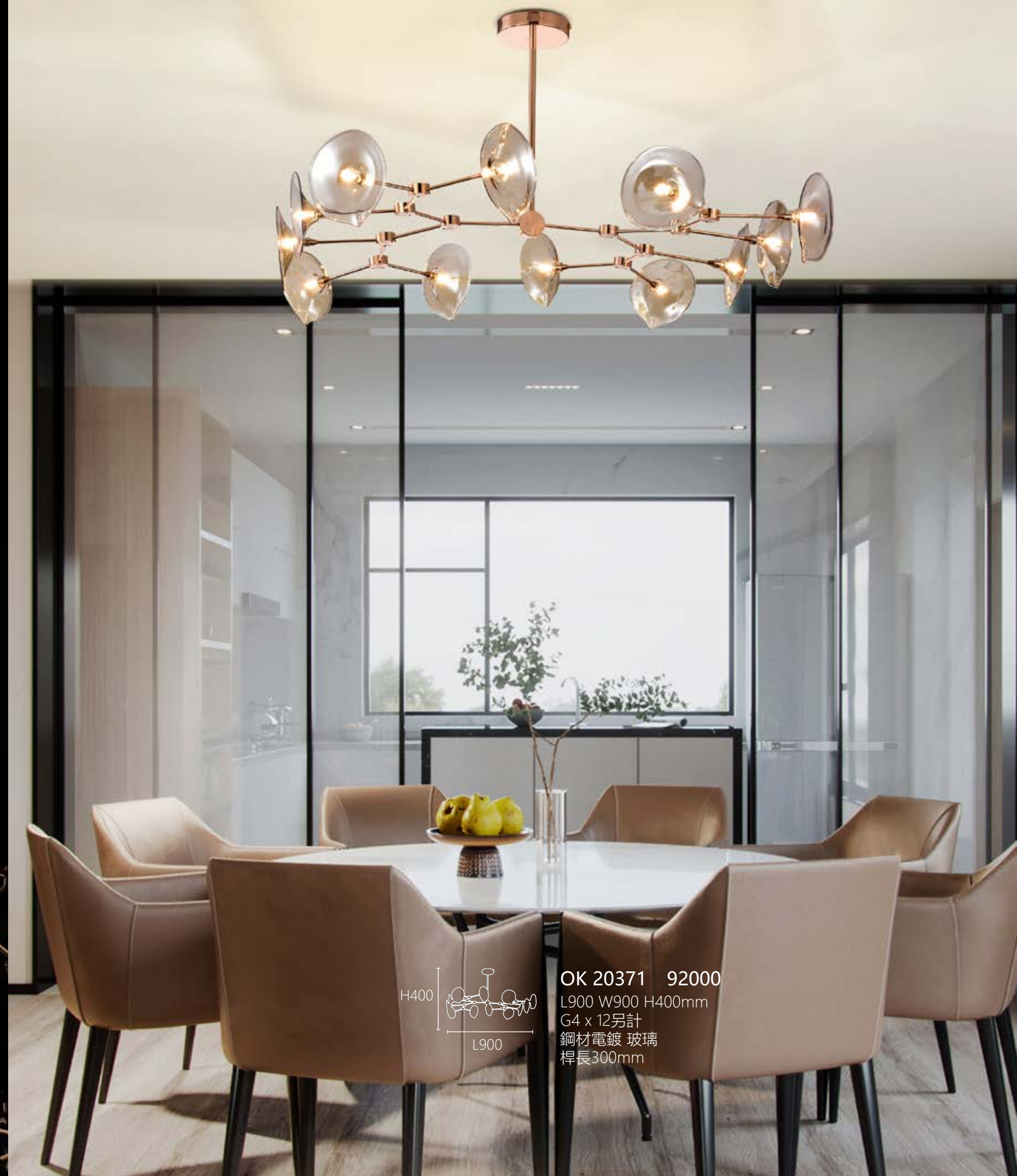

OK 20371 92000
 L900 W900 H400mm
 G4 x 12另計
 鋼材電鍍 玻璃
 桿長300mm

038

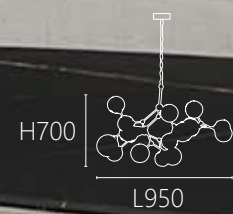

OK 20381 140000
 L950 W800 H700mm 鏈長600mm
 G9 x 15另計
 鋼材電鍍 玻璃

039

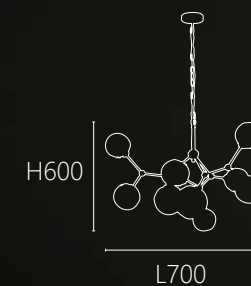

OK 20391 75000
 L700 W700 H600mm 鏈長600mm
 G9 x 9另計
 鋼材電鍍 玻璃

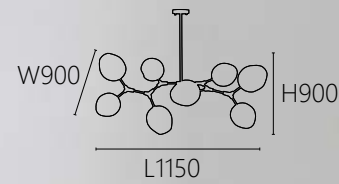

OK 20401 90000
 L1150 W900 H900mm
 E27 x 8另計
 鋼材烤漆 玻璃
 桿長250+250mm

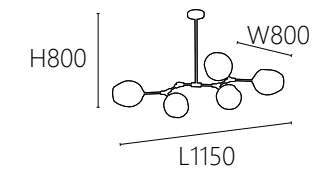

OK 20411 60000
 L1150 W800 H800mm
 E27 x 5另計
 鋼材烤漆 玻璃
 桿長250+250mm

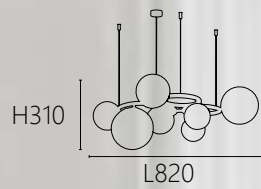

OK 20421 88000
 L820 W705 H310mm 線長1500mm
 G9 x 7 另計
 鋼材 煙灰色玻璃



OK 20431

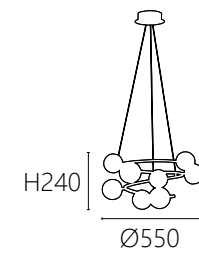

OK 20431 62000
 Ø550 H240mm 線長1000mm
 G9 x 8另計
 鋼材烤漆 玻璃

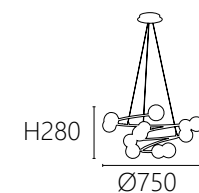

OK 20432 92000
 Ø750 H280mm 線長1000mm
 G9 x 12另計
 鋼材烤漆 玻璃



OK 20432



OK 20441

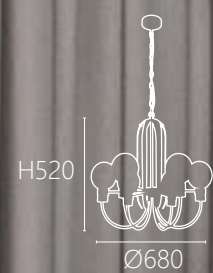

OK 20441 78000
 Ø680 H520mm 鏈長600mm
 E14 x 6另計
 鋼材烤漆 玻璃



OK 20442 18000
 D230 H270mm
 E14 x 1 另計
 鋼材烤漆 玻璃



OK 20442



OK 20451



OK 20451 25000
 Ø120 H350 D180mm
 E14 x 2另計
 鋼材電鍍 玻璃



OK 20452

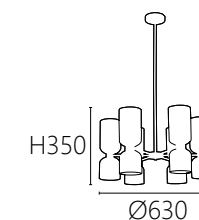

OK 20452 126000
 Ø630 H350mm 桿長800mm
 E14 x 12另計
 鋼材電鍍 玻璃
 桿長400+400mm

046

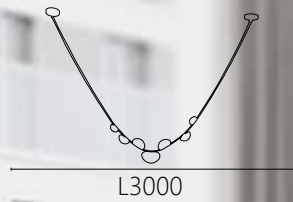

OK 20461 110000
 L3000mm
 附LED 5W x 7 3000K
 壓克力 灰色皮革 單邊可裁切

047

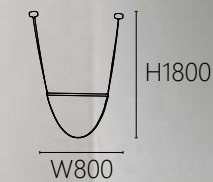

OK 20471 98000
 W800 H1800mm
 附LED 14W 3000K
 壓克力 灰色皮革 單邊可裁切

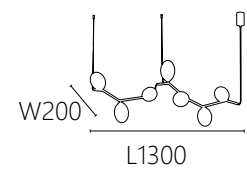
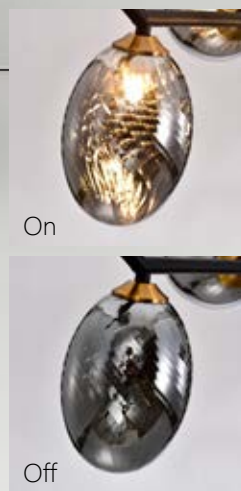

OK 20481 95000
 L1300 W200mm 線長1000mm
 G9 x 7另計
 玻璃 鋼材烤漆



OK 20491 136000
 L2300 W200mm 線長1000mm
 G9 x 12另計
 玻璃 鋼材烤漆

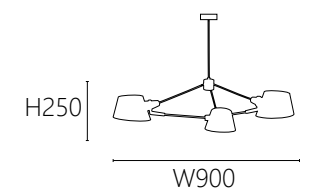

OK 20501 55000
 W900 H250mm 線長1000mm
 E27 x 3另計
 鋼材烤漆

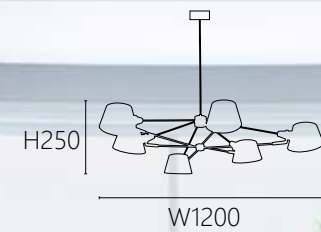
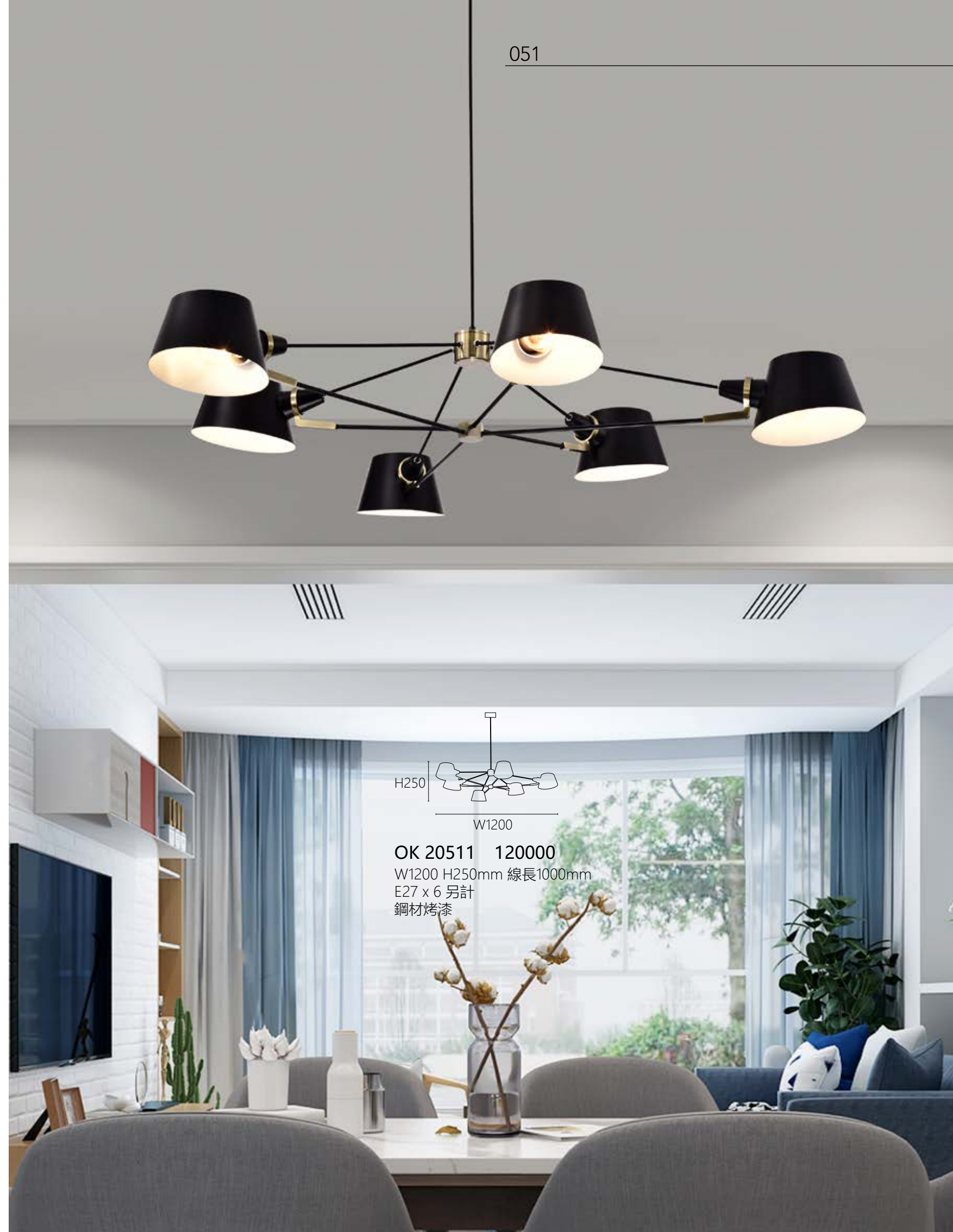

OK 20511 120000
 W1200 H250mm 線長1000mm
 E27 x 6 另計
 鋼材烤漆

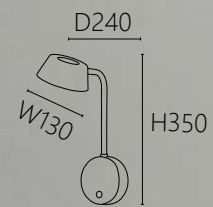

OK 20521 32000
W130 H350 D240mm
附LED 8W x 1 3000K
鋼材 附開關

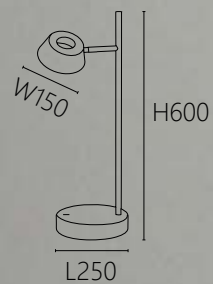

OK 20522 40000
W150 L250 H600mm
線長1500mm
附LED 8W x 1 3000K
鋼材 附開關

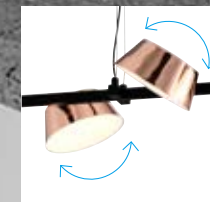
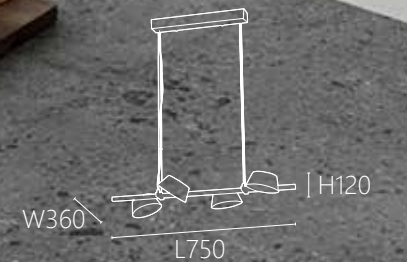

OK 20531 66000
L750 W360 H120mm
線長1500mm
附LED 8W x 4 3000K
鋼材



054

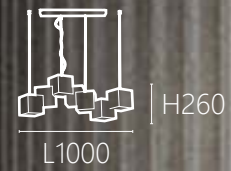

OK 20541 160000
 L1000 W270 H260mm 線長1500mm
 附LED 8W x 7 3000K
 鋼材

055

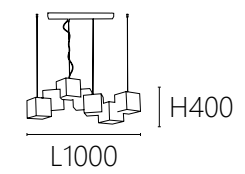

OK 20551 120000
 L1000 W360 H400mm 線長1500mm
 附LED 8W x 7 3000K
 鋼材

056

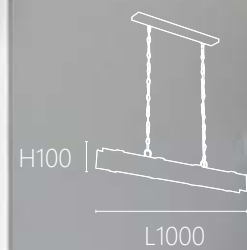

OK 20561 78000
 L1000 W75 H100mm 鏈長600mm
 內含LED 5W x 4快拆式光源
 實木 鋼材
 可選3000K/4000K

057

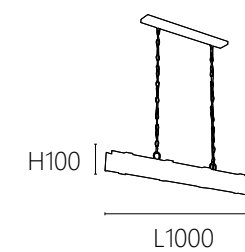

OK 20571 78000
 L1000 W75 H100mm 鏈長600mm
 內含LED 5W x 4快拆式光源
 鋼材
 可選3000K/4000K

058

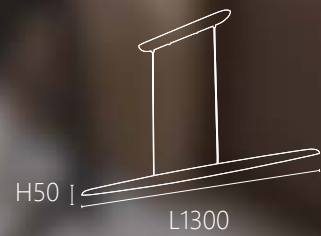

OK 20581 92000
 L1300 W70 H50mm 線長1000mm
 內附LED 15W 3000K
 實木

059

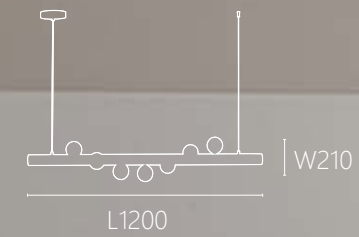

OK 20591 57000
 L1200 W210mm 線長1000mm
 G9 x 7 另計
 玻璃 實木



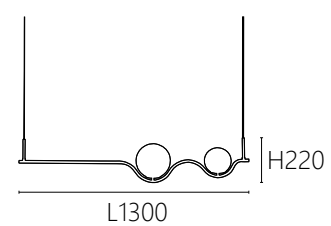
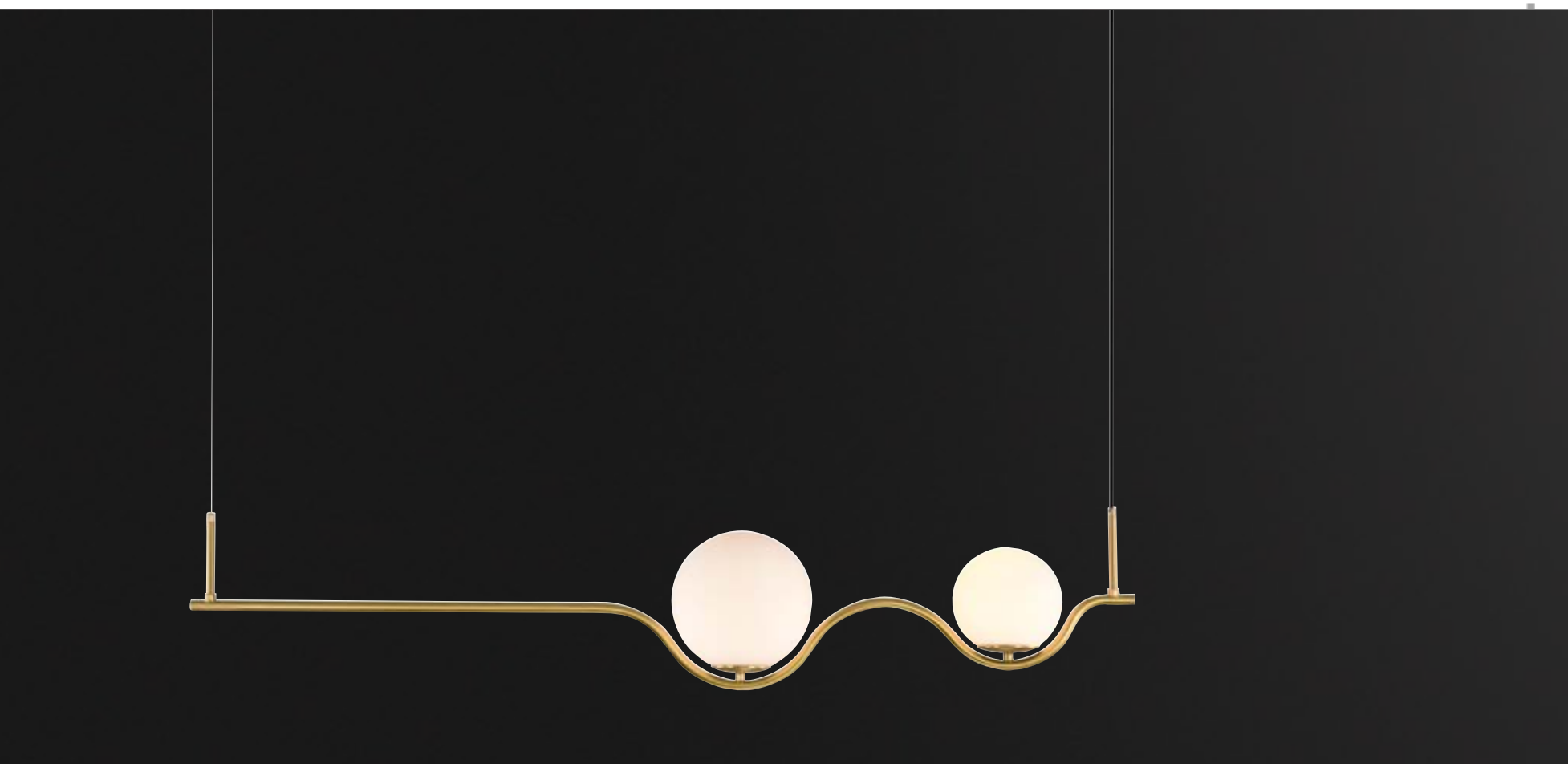

OK 20601 72000
L1300 H220mm 線長1000mm
E14 x 2 另計
全銅 玻璃

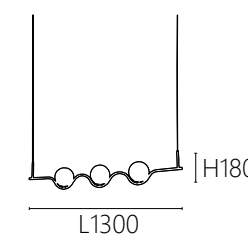

OK 20611 86000
L1300 H180mm 線長1000mm
E14 x 3 另計
全銅 玻璃

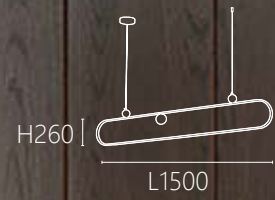

OK 20621 72000
 L1500 H260mm 線長1500mm
 內附LED 15W 3000K
 鋼材

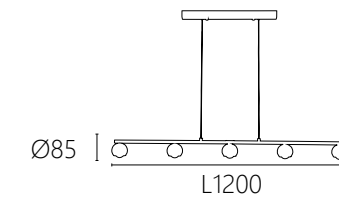

OK 20631 90000
 L1200 Ø85mm 線長1500mm
 內附LED 5W x 5 3000K
 鋁材 透鏡玻璃



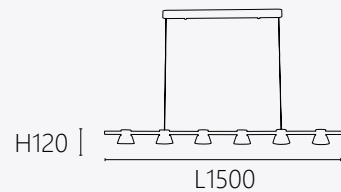

OK 20641 78000
 L1500 H120mm 線長1500mm
 內附LED 5Wx6 3000K
 鋼材 玻璃

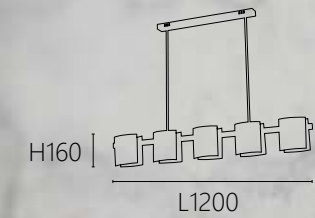

OK 20651 55000
 L1200 W120 H160mm
 桿長300+300mm
 G9 x 5另計
 鋼材 玻璃

066

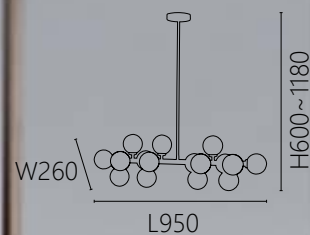

OK 20661 86000
 L950 W260 H600~1180mm
 G4 x 16另計
 鋼材電鍍 玻璃
 桿長600+300mm

067

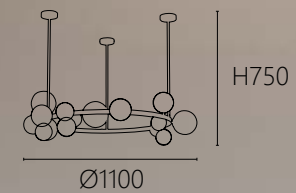

OK 20671 120000
 Ø1100 H750mm
 G9 x 15 另計
 鋼材電鍍 玻璃
 桿長600mm

068

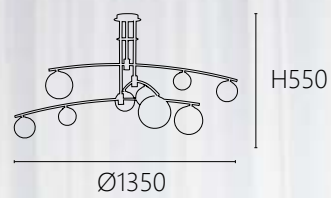

OK 20681 60000
 Ø1350 H550mm
 G9 x 9另計
 鋼材電鍍 玻璃

069

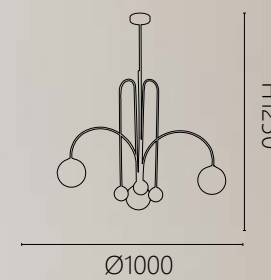

OK 20691 55000
 Ø1000 H1250mm
 G9 x 6 另計
 鋼材電鍍 玻璃

070

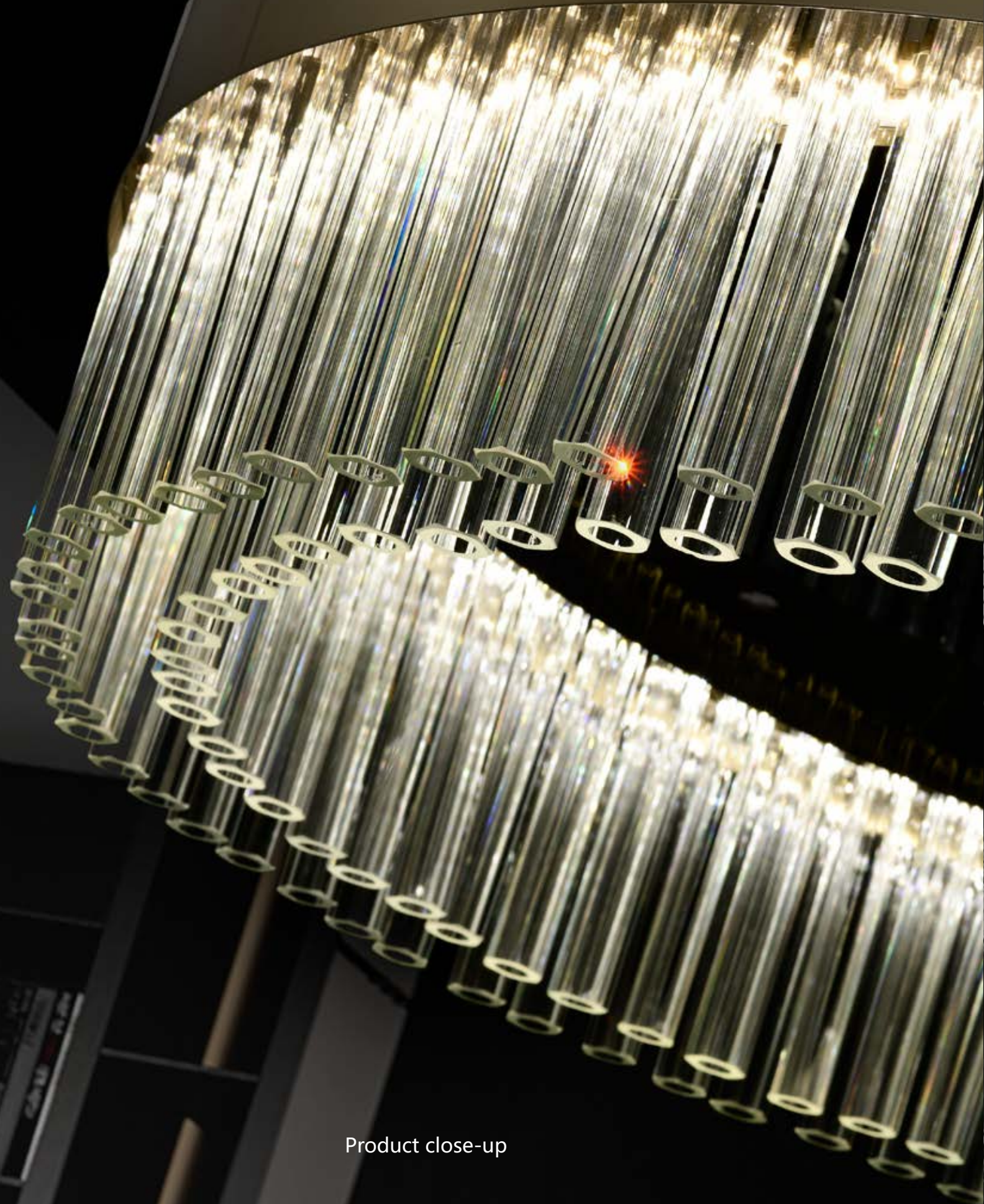

Product close-up

071

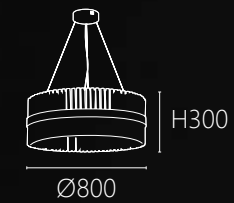

OK 20711 240000
Ø800 H300mm 線長1500mm
內附LED 50W 3000K
不銹鋼 玻璃

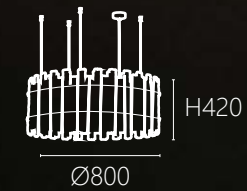

OK 20731 270000
 Ø800 H420mm 線長1500mm
 E14 x 12 另計
 鋼材 手工玻璃

074



075

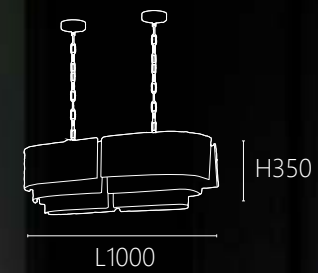

OK 20751 320000
L1000 W320 H350mm 鏈長1000mm
E14 x 12 另計
鋼材 手工玻璃

076



Product close-up

077

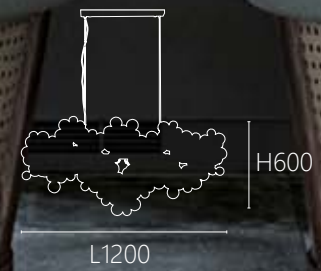

OK 20771 360000
L1200 W340 H600mm 線長1000mm
G9 x 17另計
鋼材烤漆 玻璃



OK 20781 250000
 L830 W250 H440mm 鏈長550mm
 E14 x 6 另計
 鋼材烤漆 水晶



OK 20791 280000
 Ø620 H470mm 鏈長600mm
 E14 x 8 另計
 鋼材烤漆 水晶



OK 20801 25000
 Ø110 H330mm 線長1500mm
 內附LED 5W x 1 3000K
 鋼材 清光玻璃

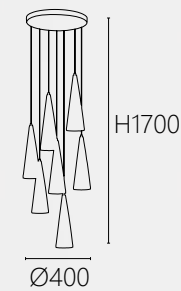

OK 20811 180000
 Ø400 H1700mm 線長1500mm
 內附LED 5W x 7 3000K
 鋼材 清光玻璃



OK 20821 25000
Ø130 H220mm 線長1500mm
E14 x 1 另計
鋼材電鍍 白玻璃



H1700 OK 20831 180000
Ø400 H1700mm 線長1500mm
E14 x 7另計
鋼材電鍍 白玻璃





H80 |  **OK 20841 15000**
 Ø152 H80mm
 內附LED 7W x 1
 木材
 可選3000K/4000K

OK 20842 15000
 Ø152 H80mm
 內附LED 7W x 1
 木材
 可選3000K/4000K

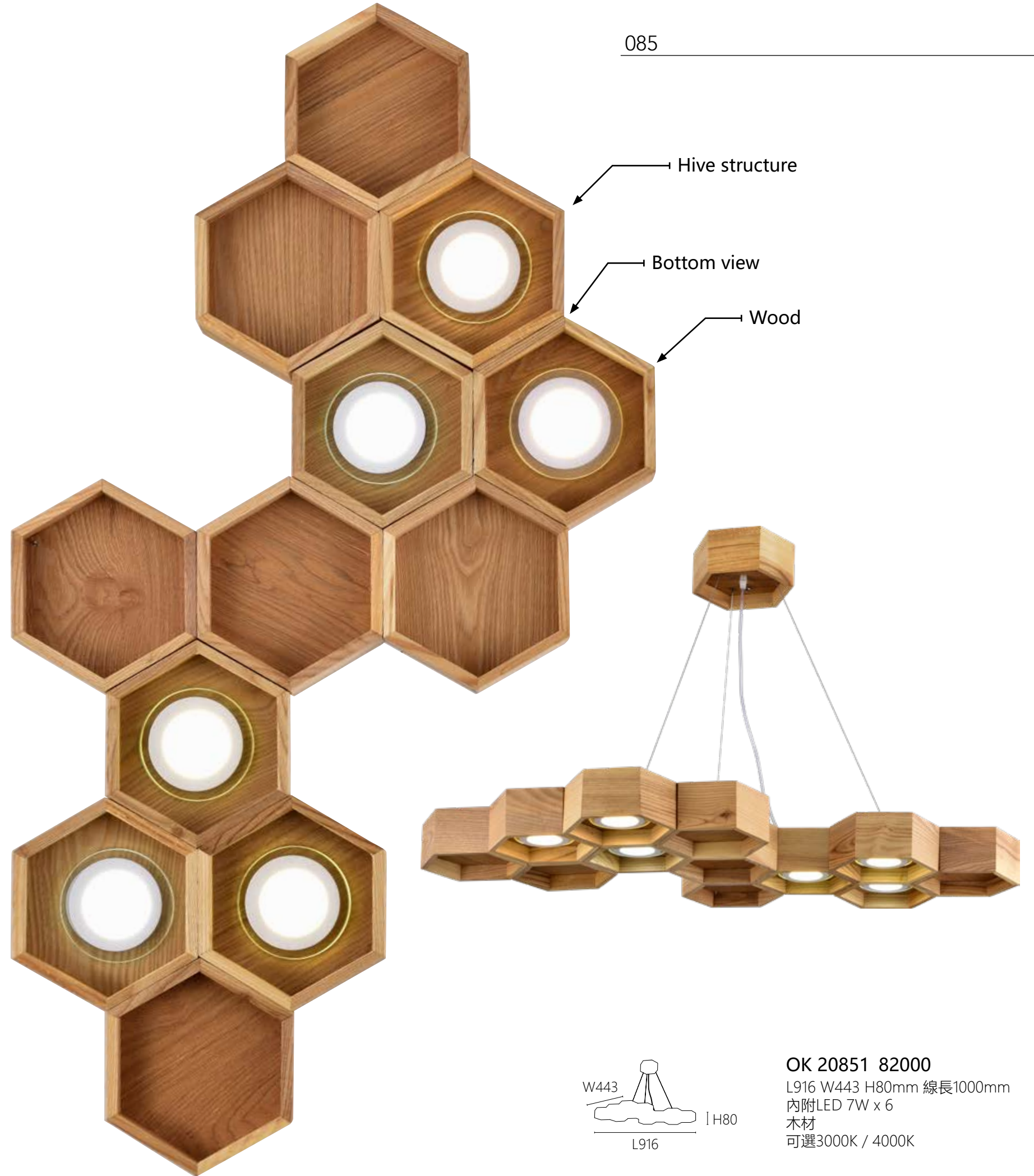

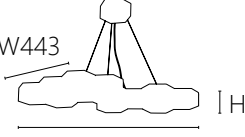
 **OK 20851 82000**
 L916 W443 H80mm 線長1000mm
 內附LED 7W x 6
 木材
 可選3000K / 4000K

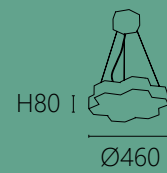

OK 20861 55000
 Ø460 H80mm 線長1000mm
 內附LED 7W x 6
 木材
 可選3000K/4000K

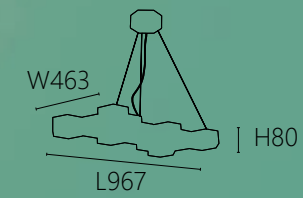

OK 20871 76000
 L967 W463 H80mm 線長1000mm
 內附LED 7W x 6
 木材
 可選3000K/4000K

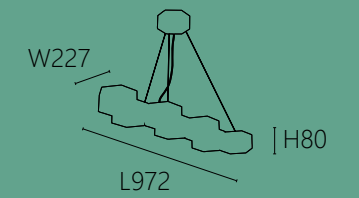

OK 20872 52000
 L972 W227 H80mm 線長1000mm
 內附LED 7W x 4
 木材
 可選3000K/4000K



OK 20881



OK 20882



OK 20891

OK 20892

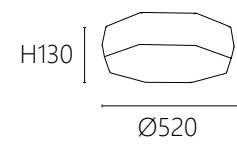

OK 20881 56000
Ø520 H130mm
E27 x 4另計
全銅 玻璃

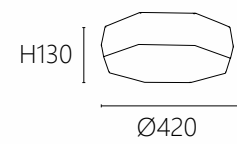

OK 20882 45000
Ø420 H130mm
E27 x 3另計
全銅 玻璃

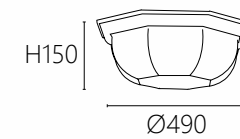

OK 20891 75000
Ø490 H150mm
E27 x 4另計
全銅 玻璃

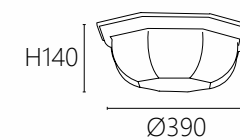

OK 20892 50000
Ø390 H140mm
E27 x 3另計
全銅 玻璃

090

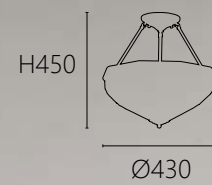

OK 20901 50000
Ø430 H450mm
E27 x 4 另計
全銅 玻璃

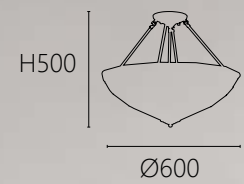

OK 20902 78000
Ø600 H500mm
E27 x 6 另計
全銅 玻璃

091



OK 20912



OK 20911

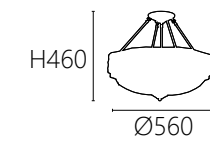

OK 20911 80000
Ø560 H460mm
E27 x 6 另計
全銅 玻璃 水晶

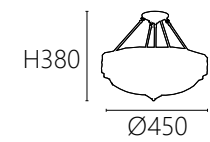

OK 20912 60000
Ø450 H380mm
E27 x 4 另計
全銅 玻璃 水晶

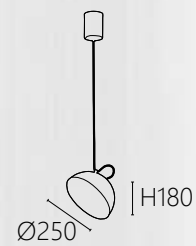

OK 20921 42000
 Ø250 H180mm 線長1500mm
 內附LED 15W 3000K
 鋼材 玻璃



OK 20931 126000
 Ø490 H180mm 線長1500mm
 內附LED 15W x 3 3000K
 鋼材 玻璃

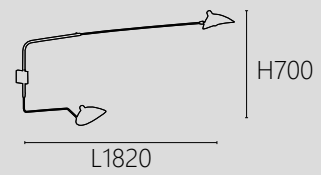

OK 20941 62000

L1820 H700mm
E14 x 2 另計
鋼材烤漆
桿身可左右搖擺

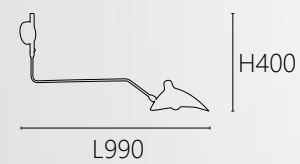

OK 20942 32000

L990 H400mm
E14 x 1 另計
鋼材烤漆
桿身可左右搖擺

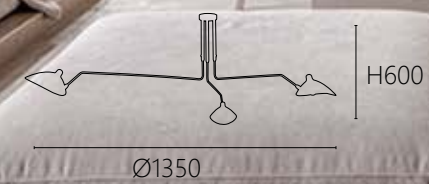

OK 20951 80000

Ø1350 H600mm
E14 x 3 另計
鋼材烤漆
桿身可左右搖擺



OK 20961
OK 20962



OK 20963



OK 20971



OK 20972



OK 20961 28000
Ø300 H280mm 線長1000mm
E27 x 1 另計
鋼材烤漆 玻璃



OK 20962 25000
Ø200 H130mm 線長1000mm
E27 x 1 另計
鋼材烤漆 玻璃

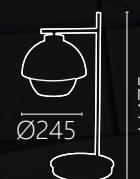

OK 20963 38000
Ø245 H475mm
E27 x 1 另計
鋼材烤漆 玻璃



OK 20971 25000
Ø200 H300mm
E27 x 1 另計
鋼材烤漆 玻璃



OK 20972 25000
W200 D270mm
E27 x 1 另計
鋼材烤漆 玻璃

098

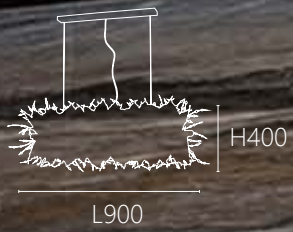

OK 20981 98000
L900 H400mm 線長1000mm
G9 x 12另計
鋼材電鍍 水晶

099



OK 20991 120000
Ø600mm 線長1000mm
G9 x 16另計
鋼材電鍍 水晶



OK 20992 82000
Ø500mm 線長1000mm
G9 x 9另計
鋼材電鍍 水晶



OK 21001

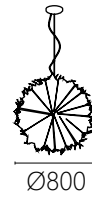

Ø800

OK 21001 80000
Ø800 H800mm 線長1000mm
G4 x 12 另計
仿木 白珠



OK 21002

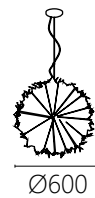

Ø600

OK 21002 46000
Ø600 H600mm 線長1000mm
G4 x 8 另計
仿木 彩珠



OK 21011

OK 21012

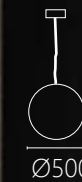

Ø500

OK 21011 68000
Ø500mm 鏈長600mm
G9 x 9 另計
鋁材電鍍 水晶



Ø600

OK 21012 92000
Ø600mm 鏈長600mm
G9 x 12 另計
鋁材電鍍 水晶





OK 21021

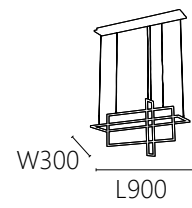

OK 21021 138000
 L900 W300 線長1000mm
 附LED 80W 4000K
 不銹鋼電鍍 壓克力

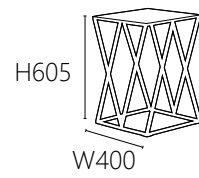

OK 21022 160000
 L400 W400 H605mm
 附LED 64W 4000K
 不銹鋼電鍍 壓克力

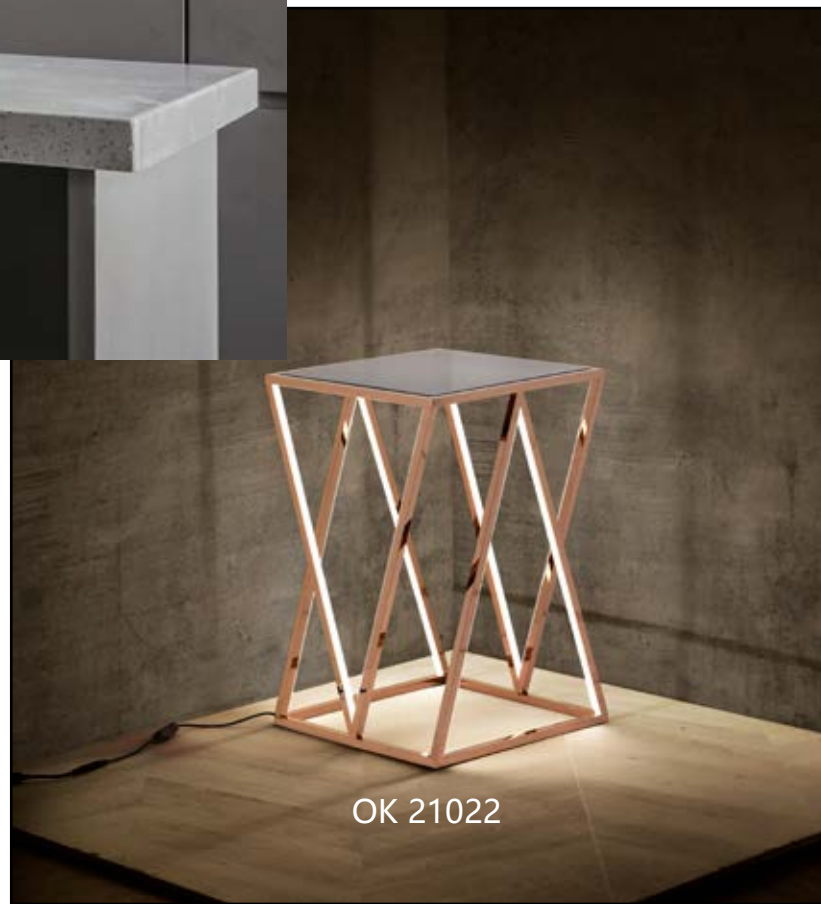

OK 21022

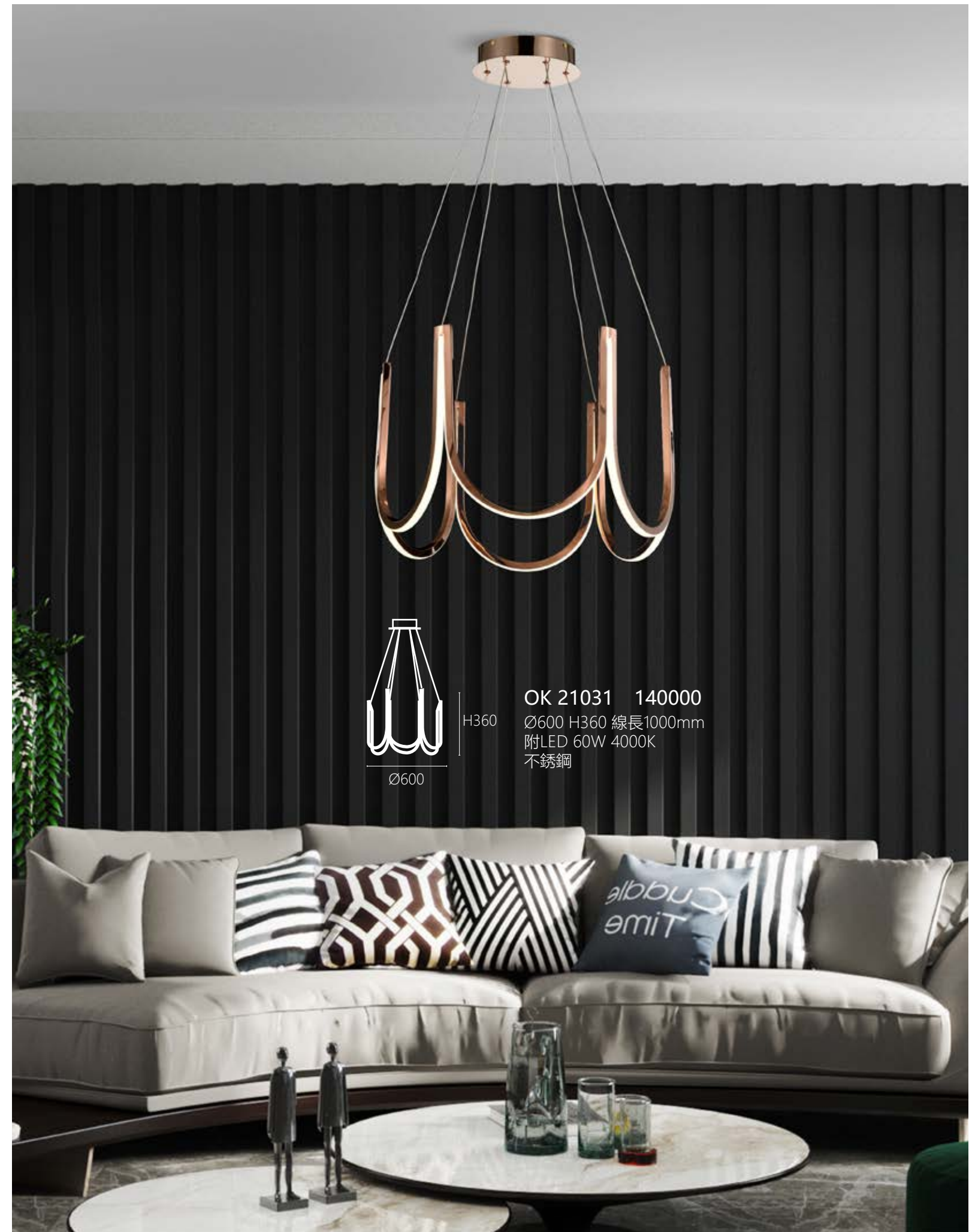

OK 21031 140000
 Ø600 H360 線長1000mm
 附LED 60W 4000K
 不銹鋼

Stainless steel electroplating liner lighting

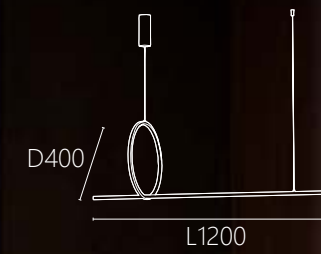
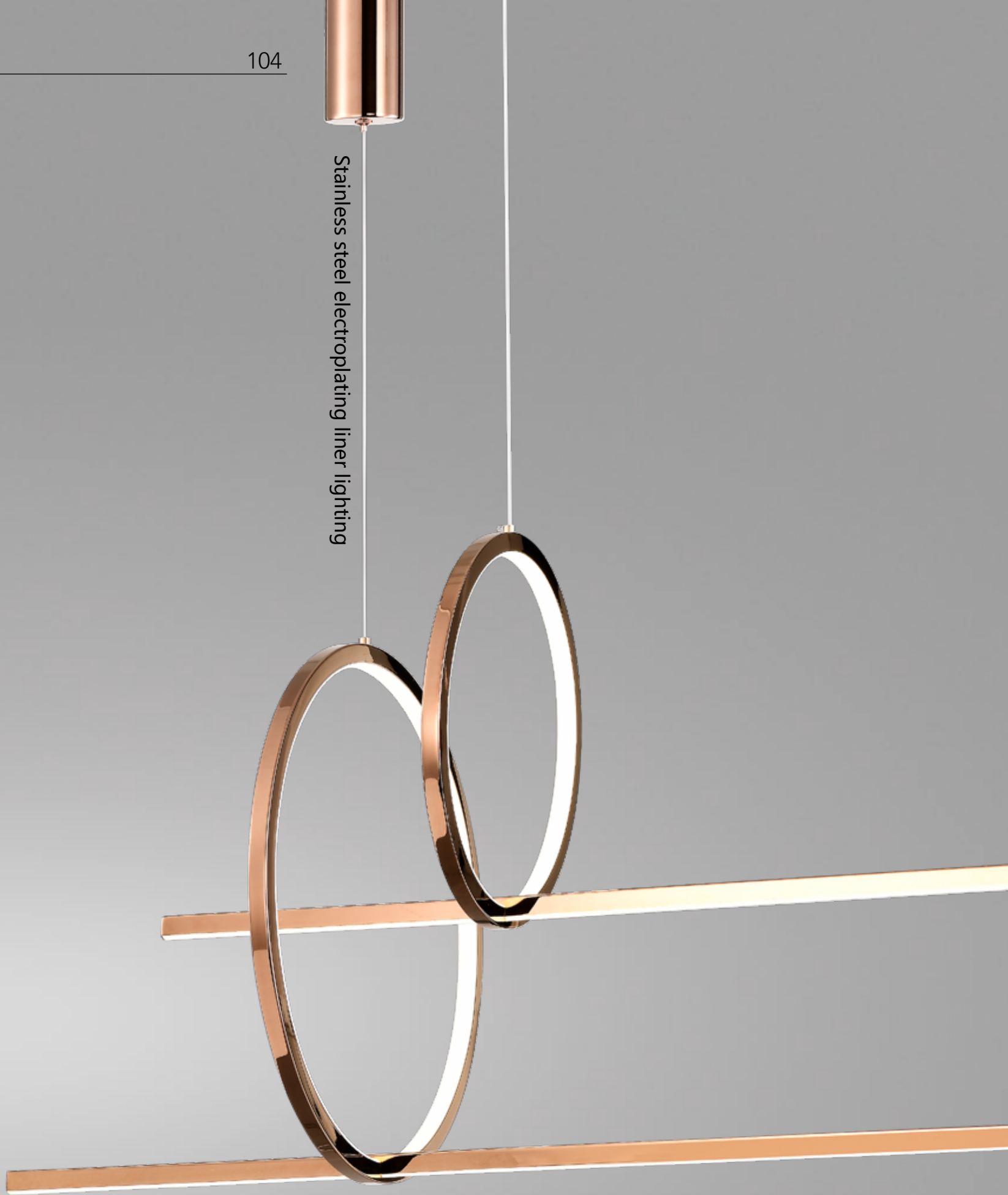

OK 21051 90000
 L1200 D400 線長1000mm
 附LED 30W 4000K
 不銹鋼電鍍

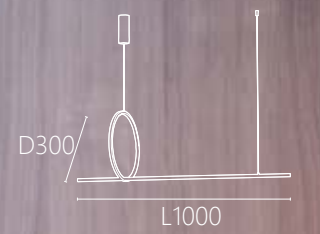

OK 21052 76000
 L1000 D300 線長1000mm
 附LED 25W 4000K
 不銹鋼電鍍

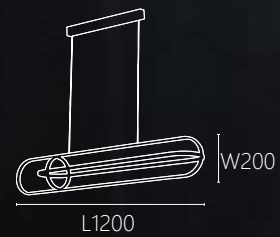

OK 21061 78000
L1200 W200 線長1500mm
內含LED 45W 3000K
鋼材

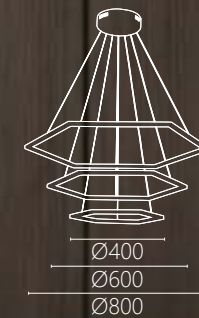

OK 21071 120000
Ø400 x 1/ Ø600 x 1/ Ø800 x 1 線長1500mm
內含LED 55W 4000K
不銹鋼電鍍 壓克力

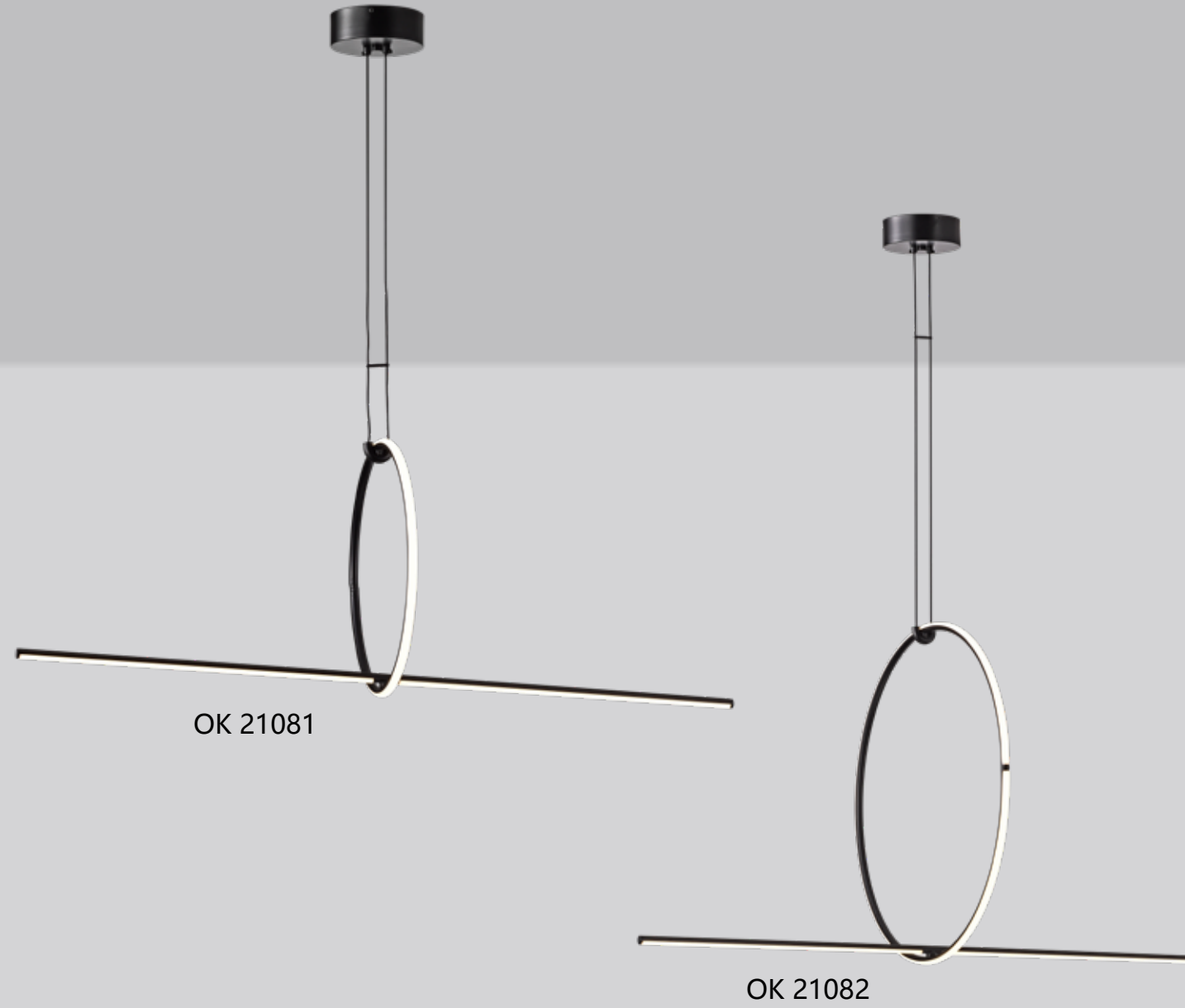

OK 21081

OK 21082

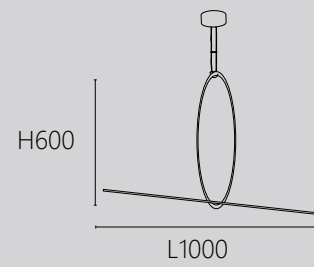
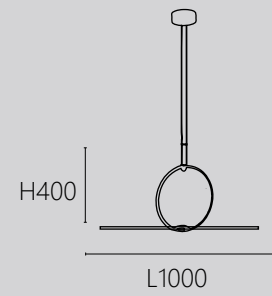

OK 21081 96000

L1000 H400mm 線長1000mm
內附LED 30W 4000K
壓克力 硅膠
內附明緯變壓器

OK 21082 110000

L1000 H600mm 線長1000mm
內附LED 40W 4000K
壓克力 硅膠
內附明緯變壓器

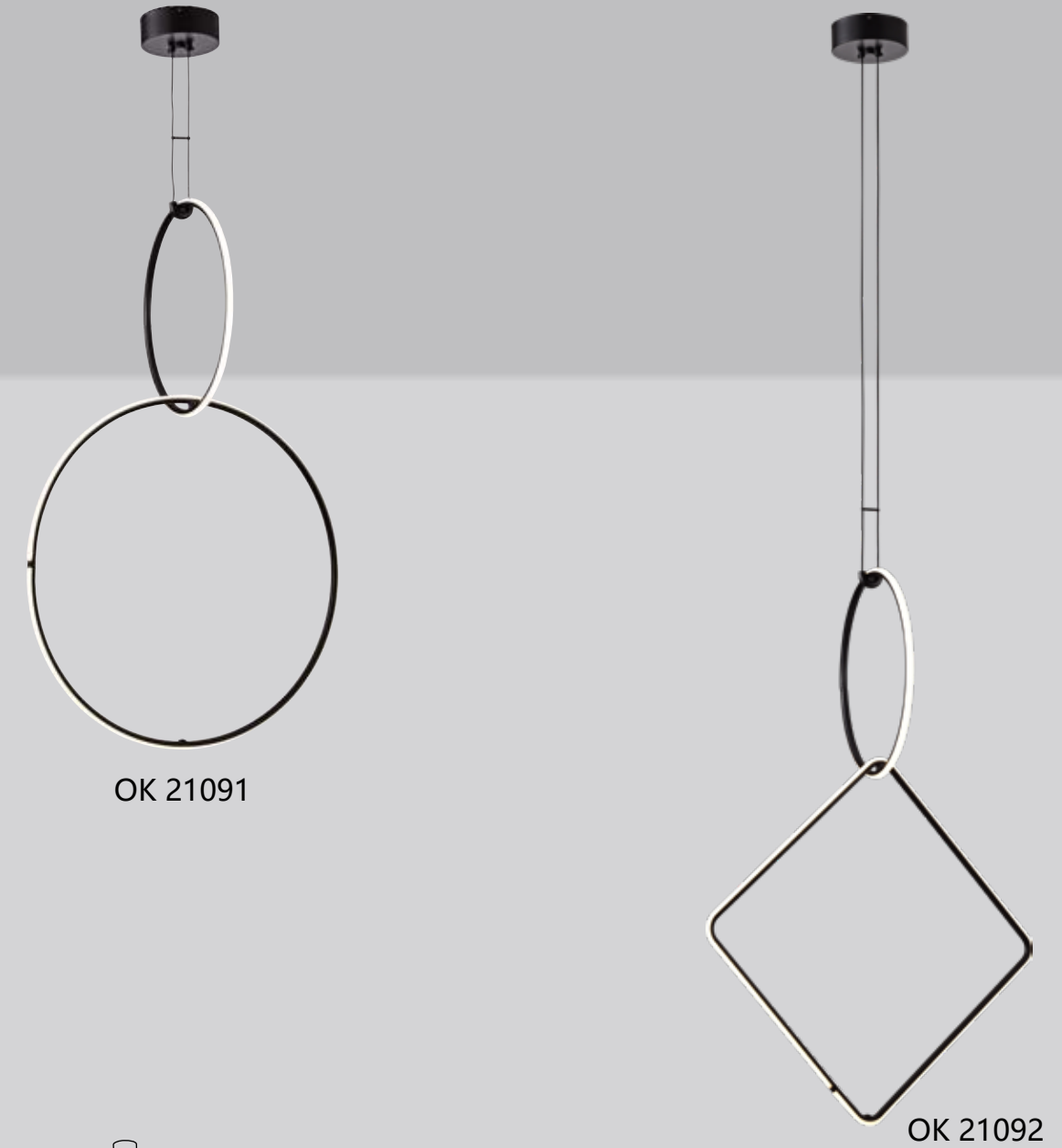

OK 21091

OK 21092

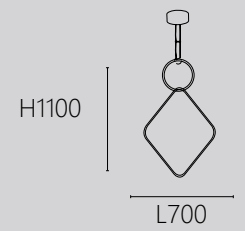
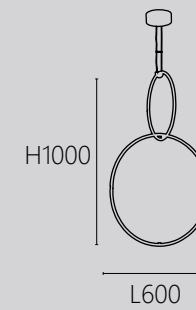

OK 21091 142000

L600 H1000mm 線長1000mm
內附LED 45W 4000K
壓克力 硅膠
內附明緯變壓器

OK 21092 142000

L700 H1100mm 線長1000mm
內附LED 45W 4000K
壓克力 硅膠
內附明緯變壓器

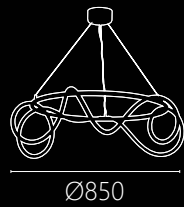
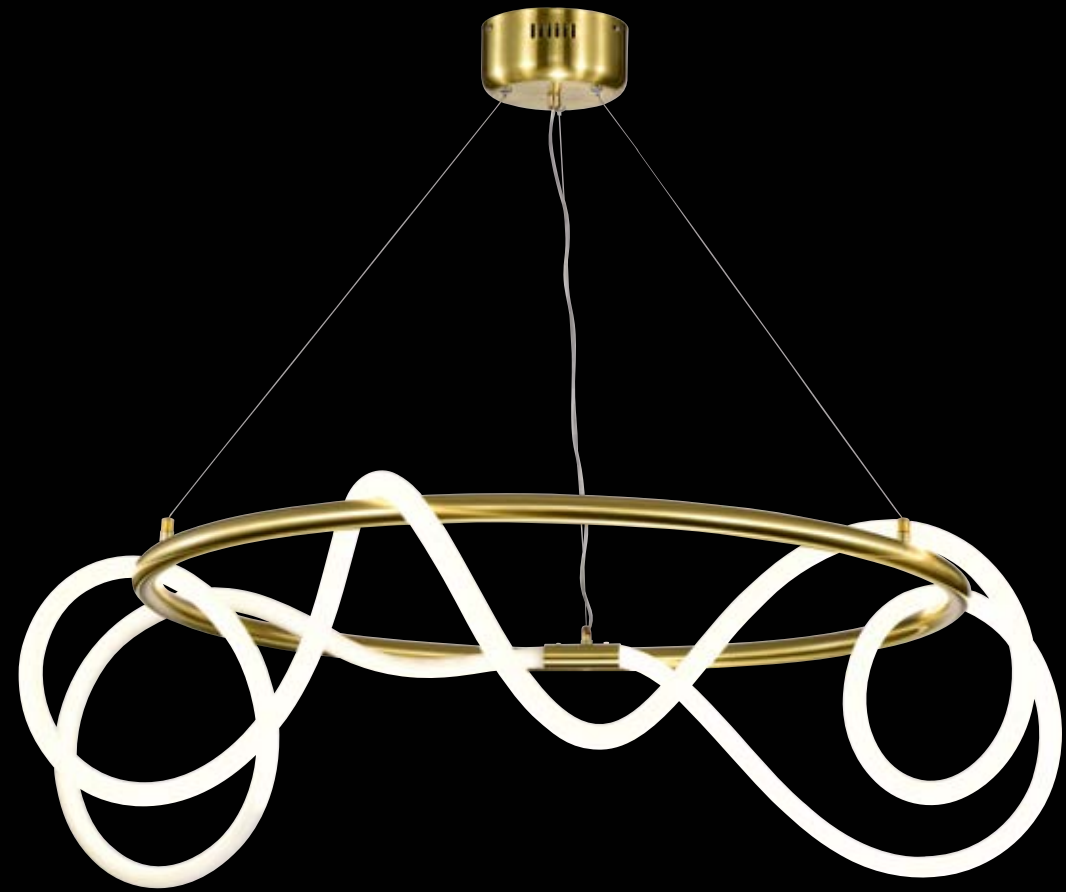

OK 21101 126000
Ø850 線長1500mm
附LED 65W 4000K
編織硅膠 鋼材
內附明緯變壓器

編織

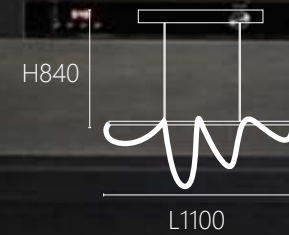

OK 21111 108000
L1100 H840mm
附LED 50W 4000K
編織硅膠 鋼材
內附明緯變壓器

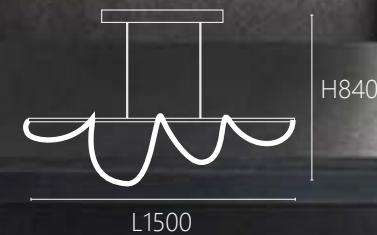

OK 21112 120000
L1500 H840mm
附LED 65W 4000K
編織硅膠 鋼材
內附明緯變壓器

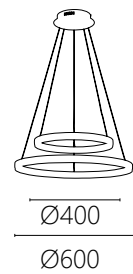

OK 21121 92000
 Ø600+Ø400mm
 線長2000mm
 附LED 60W 3000K
 皮革 鋁材

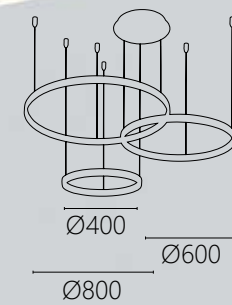

OK 21131 140000
 Ø800+Ø600+Ø400mm
 線長1200mm
 附LED 108W 3000K
 皮革 鋁材



OK 21141 36000
 L400 W110 H540mm
 E14 x 2 另計
 皮革 玻璃
 線長1500mm

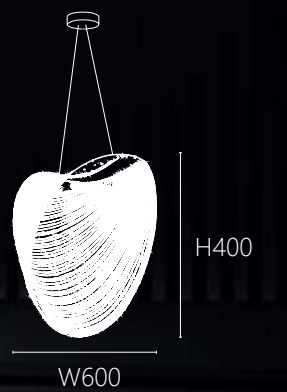

OK 21151 62000
 W600 H400mm
 附LED 20W 3000K
 木材



 H1000
 Ø750
OK 21161 1100000
 Ø750 H1000mm 鏈長600mm
 附LED 150W 3000K
 鋼材電鍍 手工玻璃
 內附明緯驅動器





OK 21181



OK 21182

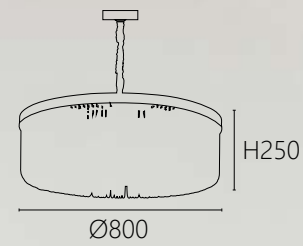

OK 21181 280000
Ø800 H250mm 鏈長600mm
E14 x 15 另計
鋼材電鍍 玻璃

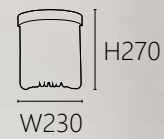

OK 21182 42000
D150 W230 H270mm
E14 x 2 另計
鋼材電鍍 玻璃

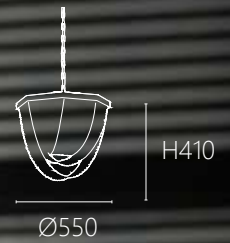

OK 21191 250000
Ø550 H410mm 鏈長800mm
E14 x 11另計
鋼材電鍍 水晶串珠



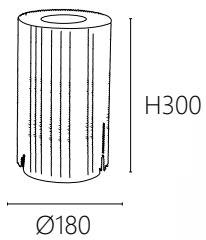

OK 21201 45000
 Ø180 H300mm
 E14 x 1 另計
 不銹鋼 鋼珠串

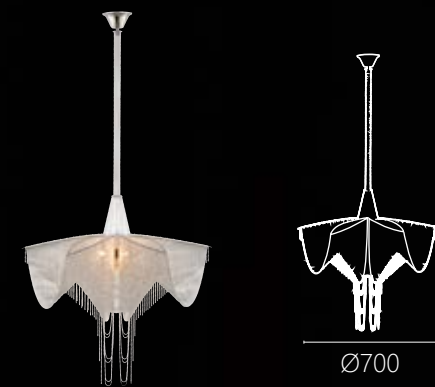

OK 21211 160000
 Ø700 H1450mm 鏈長600mm
 G9 x 7 另計
 不銹鋼電鍍 鋼珠串

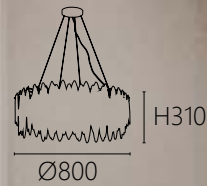

OK 21221 180000
 Ø800 H310mm 線長1000mm
 E14 x 10 另計
 鋼材電鍍 不銹鋼 玻璃



OK 21231



OK 21232

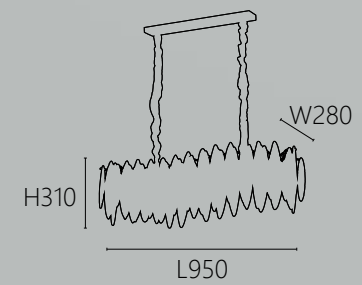

OK 21231 168000
 L950 W280 H310mm
 鏈長600mm
 E14 x 6 另計
 鋼材電鍍 不銹鋼 玻璃

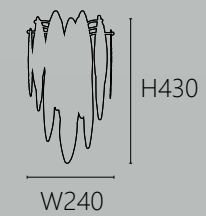

OK 21232 36000
 W240 H430 D180mm
 E14 x 1 另計
 鋼材電鍍 不銹鋼 玻璃

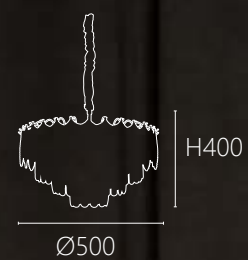

OK 21241 78000
 Ø500 H400mm 鏈長600mm
 E14 x 7 另計
 鋼材電鍍 玻璃



OK 21242 96000
 Ø600 H450mm 鏈長600mm
 E14 x 10 另計
 鋼材電鍍 玻璃

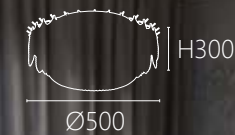

OK 21251 75000
 Ø500 H300mm
 E14 x 10 另計
 鋼材電鍍 玻璃





OK 21261 98000
 Ø360 H400mm 線長1500mm
 附LED 20W 3000K
 鋼材 壓克力

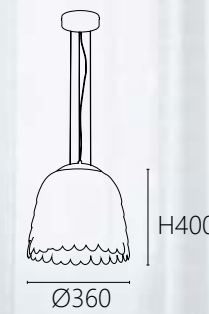

OK 21271 95000
 Ø360 H400mm 線長1500mm
 附LED 20W 3000K
 鋼材 壓克力

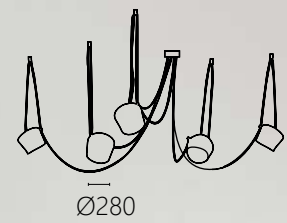

OK 21281 92000
 Ø280mm
 線長2米x2 + 3米x2 + 4米x1
 E27 x 5 另計
 鋼材烤漆



OK 21282 25000
 Ø280mm
 線長2500mm
 E27 x 1另計
 鋼材烤漆

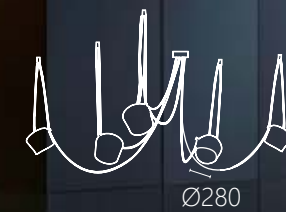
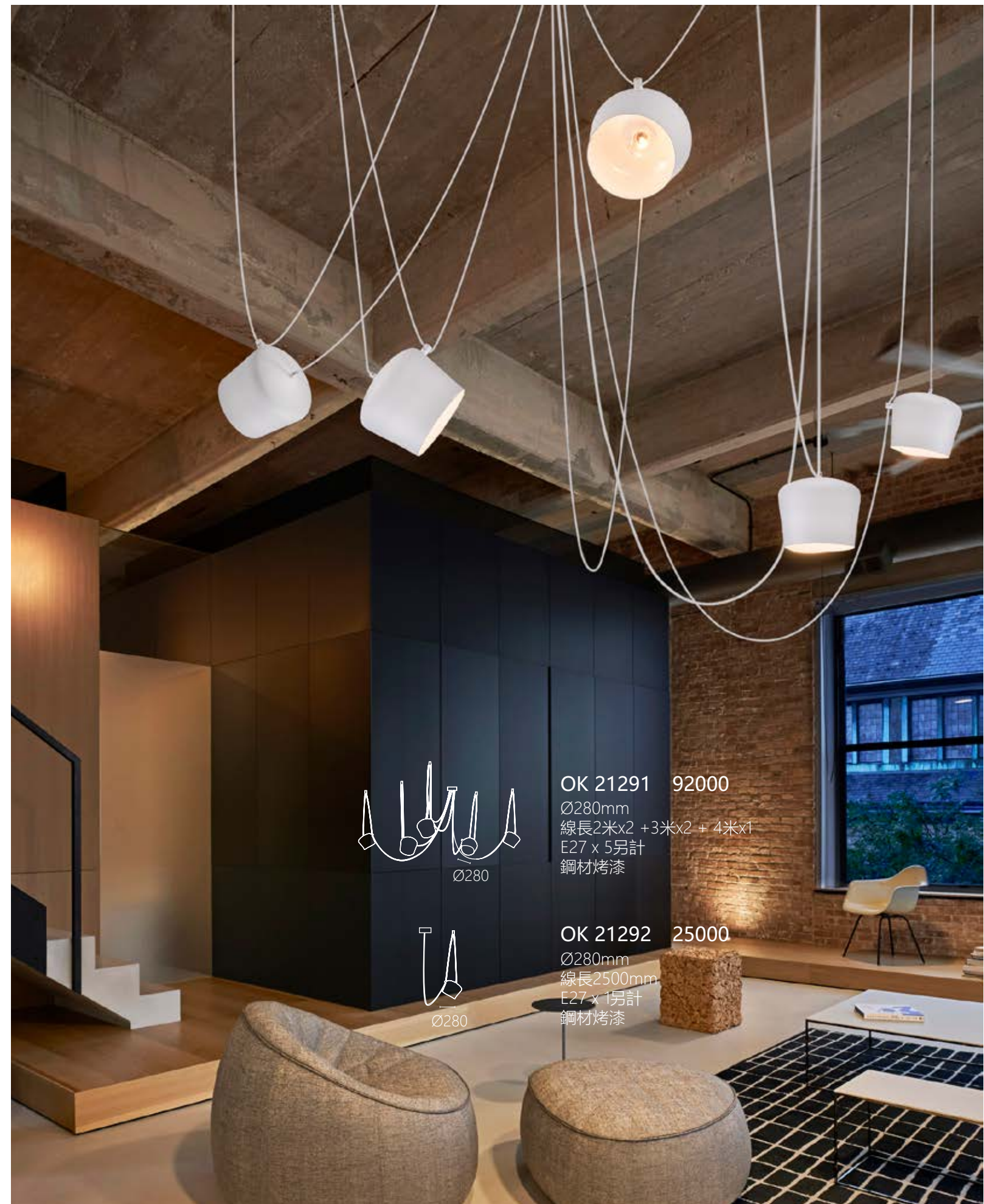

OK 21291 92000
 Ø280mm
 線長2米x2 + 3米x2 + 4米x1
 E27 x 5另計
 鋼材烤漆



OK 21292 25000
 Ø280mm
 線長2500mm
 E27 x 1另計
 鋼材烤漆

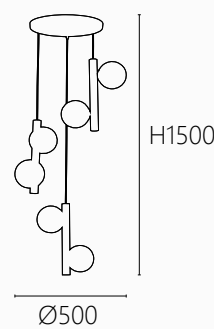

OK 21301 90000
 Ø500 H1500mm
 G9 x 6 另計
 鋼材烤漆 玻璃
 線長1500mm

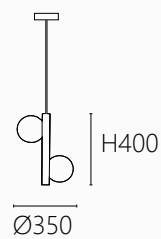

OK 21302 32000
 Ø350 H400mm
 G9 x 2 另計
 鋼材烤漆 玻璃
 線長1500mm



OK 21311 25000
 W100 H500 D170 mm
 G9 x 1 另計
 鋼材烤漆 玻璃



OK 21312 42000
 W200 H360mm
 內附LED 8W 4000K
 鋁材烤漆

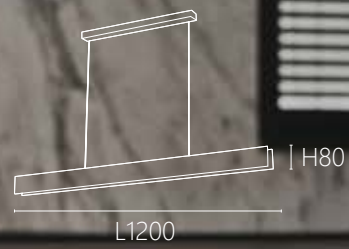

OK 21321 68000
L1200 H80mm
內附LED 25W 4000K
鋼材 壓克力
線長1500mm

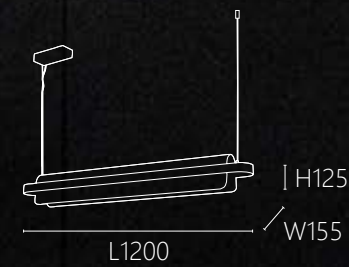

OK 21331 135000
L1200 W155 H125mm
線長1500mm
內附LED 45W 4000K
不銹鋼電鍍 壓克力
線長1500mm

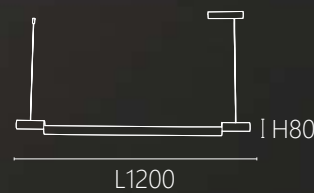
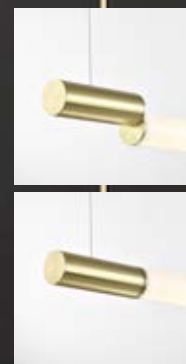

OK 21341 82000
 L1300 H80mm 線長1500mm
 內附LED 28W 3000K
 鋁材電鍍 壓克力

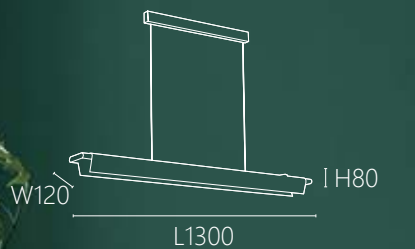

OK 21351 96000
 L1300 W120 H80mm 線長1500mm
 內附LED 36W 全電壓 3000K
 鋁材 實木



OK 21361

OK 21362

OK 21361 48000
 L1200 W40 H90mm 線長1000mm
 內附LED 35W
 鋁材烤漆
 可選3000K/4000K
 發光面擴散板

OK 21362 48000
 L1200 W40 H90mm 線長1000mm
 內附LED 35W
 鋁材烤漆
 可選3000K/4000K
 發光面擴散板

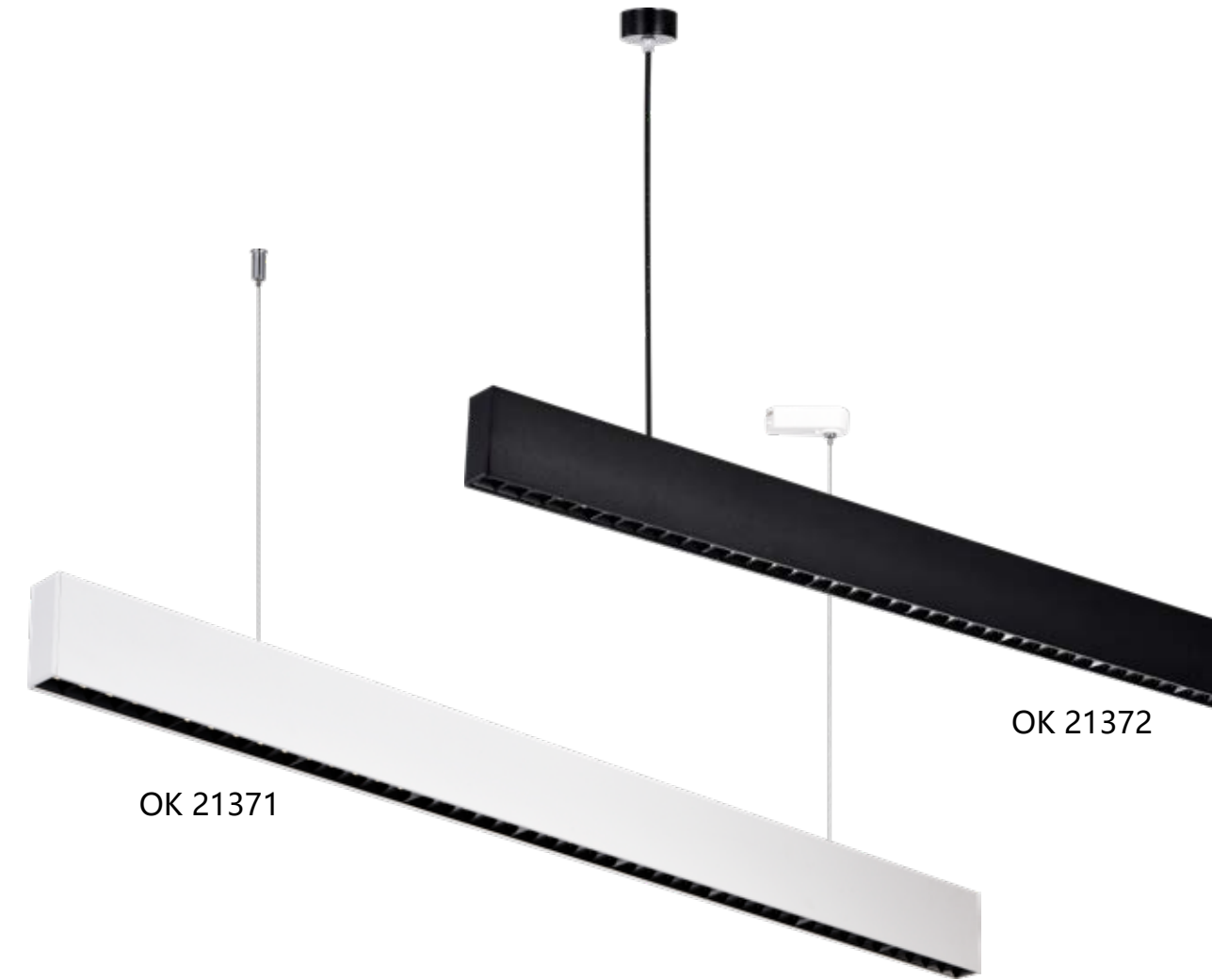

OK 21371

OK 21372

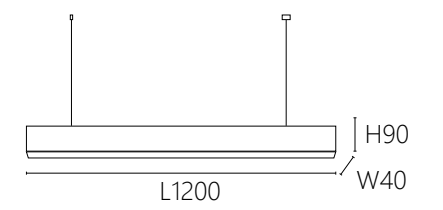
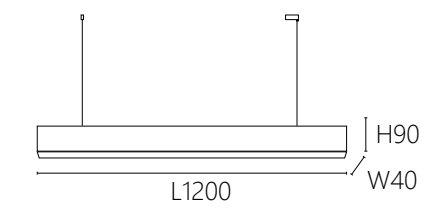

OK 21371 55000
 L1200 W40 H90mm 線長1000mm
 內附LED 35W
 鋁材烤漆
 可選3000K/4000K
 發光面反射杯

OK 21372 55000
 L1200 W40 H90mm 線長1000mm
 內附LED 35W
 鋁材烤漆
 可選3000K/4000K
 發光面反射杯

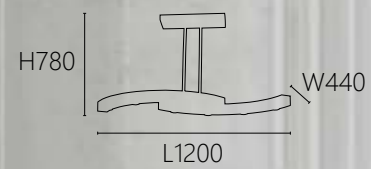

OK 21381 160000

L1200 W440 H780mm
 內附LED 5W x 8 快拆式光源
 鋁材烤漆
 可選3000K/4000K
 桿長500+200mm

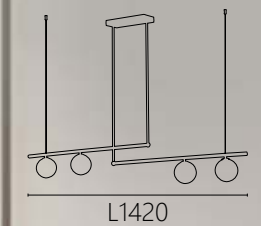

OK 21391 60000

L1420 H900mm
 G9 x 4 另計
 鋁材烤漆 玻璃
 桿長 長800mm / 短700mm

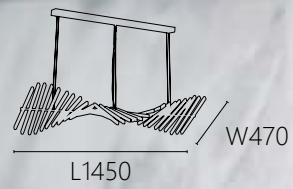

OK 21401 260000

L1450 W470mm
 內含LED 150W 3000K
 鋁材
 附遙控 無極調光
 線長1500mm

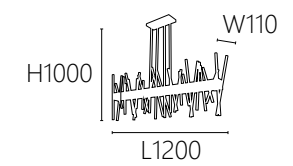

OK 21411 220000

L1200 W110 H1000mm
 內含LED 5W x 7 快拆式光源
 鋁材電鍍
 可選3000K/4000K

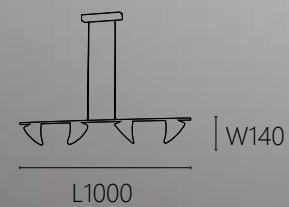
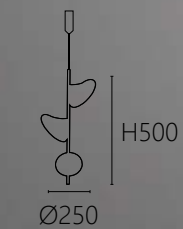

OK 21421 48000
 Ø250 H500mm 線長1000mm
 LED 10W x 3 3000K
 鋁材烤漆 壓克力

OK 21422 60000
 L1000 W140mm 線長1000mm
 LED 10W x 4 3000K
 鋁材烤漆 壓克力

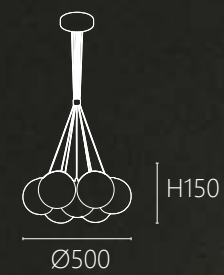

OK 21431 62000
 Ø500 H150mm 線長1000mm
 附LED 8W x 7 3000K
 鋼材 玻璃

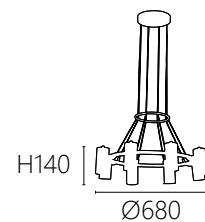

OK 21441 132000
 Ø680 H140mm 線長1000mm
 內含LED 5W x 8 快拆式光源
 鋁材電鍍
 可選3000K/4000K

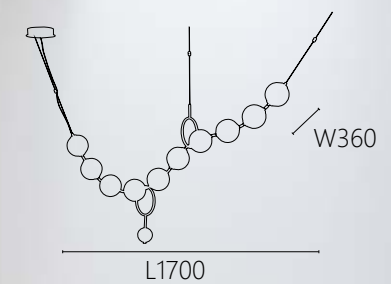

OK 21451 140000
 L1700 W360mm
 內含LED 5W x 10 3000K
 鋼材電鍍 玻璃
 內附明緯變壓器



OK 21461



OK 21461 24000
Ø200 H300mm 線長1500mm
E14 x 1 另計
鋁材電鍍 玻璃



OK 21462

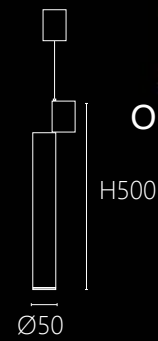

OK 21462 45000
Ø50 H580mm 線長1500mm
內含LED 12W 3000K
鋁材電鍍 壓克力



OK 21471



OK 21472



OK 21471/2 22000
Ø150 H290mm 線長1000mm
E27 x 1另計
鋁材烤漆

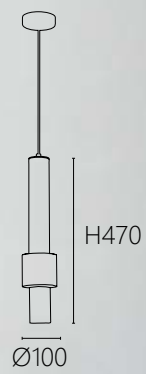

OK 21481 36000
Ø100 H470mm 線長1500mm
LED 5W x 1 / MR16 x 1 3000K
鋁材



OK 21491 36000
Ø100 H470mm 線長1500mm
LED 5W x 1 / MR16 x 1 3000K
鋁材

150



OK 21501

OK 21502



OK 21501/2 38000
 Ø350 H130mm 線長1000mm
 內含LED 10W 3000K
 鋼材

151



OK 21511

OK 21512



OK 21511/2 26000
 Ø200 H120mm 線長1000mm
 內含LED 12W 3000K
 鋼材電鍍 大理石



OK 21521



OK 21522



OK 21521/2 55000
Ø350 H500mm 線長1000mm
E27 x 1 另計
鋼材電鍍
折彎臂可擺動



OK 21531 96000
Ø450 H400mm 鏈長600mm
G9 x 3 另計
鋼材電鍍 玻璃



OK 21541



OK 21542



Ø300

OK 21541/2 16000
Ø300 H300mm 線長1000mm
E27 x 1 另計
鋼材烤漆



OK 21551



OK 21552



H240

Ø360

OK 21551 32000
Ø360 H240mm 線長1500mm
內含LED 8W 4000K
鋼材

OK 21552 28000
Ø360 H240mm 線長1500mm
內含LED 8W 4000K
鋼材



OK 21561



OK 21561 52000
 Ø450mm 線長1500mm
 E27 x 1 另計
 彈性布



OK 21562 52000
 Ø280 H370mm 線長1500mm
 E27 x 1 另計
 彈性布



OK 21572



OK 21571 48000
 Ø500 H420mm 線長1000mm
 E27 x 1另計
 彈性布



OK 21572 48000
 Ø300 H550mm 線長1000mm
 E27 x 1另計
 彈性布

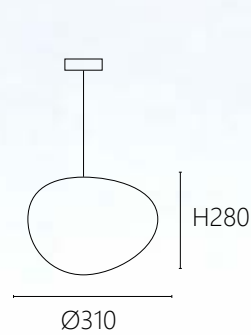

OK 21581 24000
 Ø310 H280mm 線長1500mm
 E27 x 1另計
 鋼材 滾塑

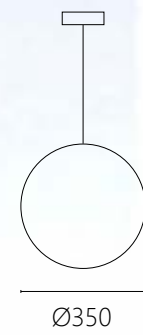

OK 21582 30000
 Ø350mm 線長1500mm
 E27 x 1另計
 鋼材 滾塑



OK 21591 30000
 Ø450 H350mm 線長1500mm
 內含LED 36W x 2 三段式光色
 鋼材 滾塑

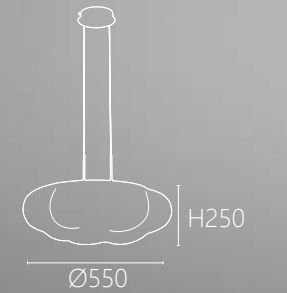

OK 21592 30000
 Ø550 W350 H250mm
 線長1500mm
 內含LED 36W x 2 三段式光色
 鋼材 滾塑



OK 21601



OK 21602



OK 21601/2 28000
Ø100mm 線長1500mm
內含LED 7W 3000K
透鏡玻璃 可隨意升降



OK 21611 28000
Ø100mm 線長1500mm
內含LED 7W 3000K
透鏡玻璃 可隨意升降





OK 21622



OK 21621



OK 21623



Ø100



OK 21621-3 28000
Ø100mm 線長1500mm
內含LED 7W 3000K
透鏡玻璃 可隨意升降



OK 21641

OK 21642

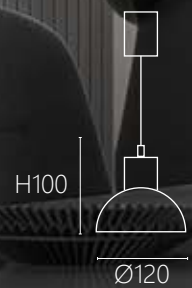

OK 21641/2 30000
 Ø120 H100mm 線長1500mm
 內含LED 5W x 1 快拆式光源
 可選3000K / 4000K
 鋁材 可隨意升降



OK 21651 33000
 Ø260 H520mm 線長1500mm
 E27 x 1 另計
 玻璃 鋼材

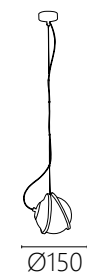

OK 21652 23000
 Ø150mm 線長1500mm
 G9 x 1 另計
 玻璃 鋼材



OK 21662



OK 21661

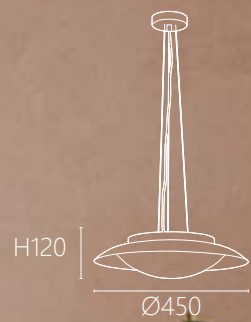

OK 21661/2 52000
Ø450 H120mm 線長1000mm
內含LED 36W 3000K
鋼材烤漆 玻璃

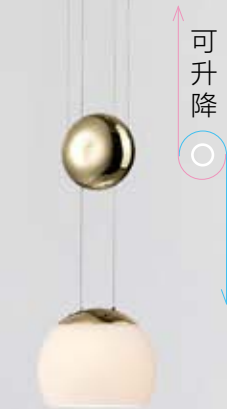

OK 21672



OK 21671

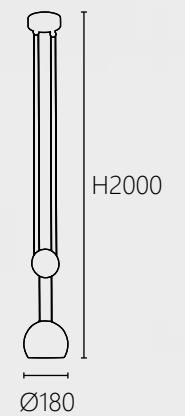

OK 21671/2 48000
Ø180 H2000mm
內附LED 5W x 1 3000K
鋼材電鍍 玻璃



OK 21691

OK 21692

OK 21693

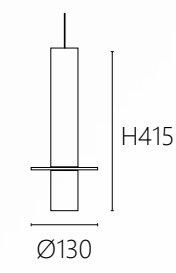

OK 21691~3 36000
 Ø130 H415mm 線長1000mm
 內含LED 5W x 1快拆式光源
 大理石 鋁材電鍍
 可選3000K/4000K

170



OK 21701



OK 21702



OK 21701/2 25000
Ø60 H365mm 線長1000mm
內含LED 5W x 1 快拆式光源
鋁材烤漆
可選3000K/4000K

171



OK 21711



OK 21712



OK 21711/2 24000
Ø70 H420mm 線長1000mm
內含LED 5W x 1 快拆式光源
鋁材烤漆 玻璃
可選3000K/4000K

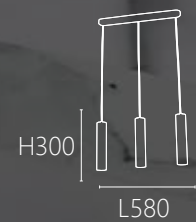

OK 21721 36000
L580 W60 H300mm 線長1000mm
內含LED 5W x 3快拆式光源
鋁材烤漆
可選3000K/4000K



OK 21722 12000
Ø60 H300mm 線長1000mm
內含LED 5W x 1快拆式光源
鋁材烤漆
可選3000K/4000K
可選軌道式

可選軌道式



OK 21731 12000
Ø60 H300mm 線長1000mm
內含LED 5W x 1快拆式光源
鋁材烤漆
可選3000K/4000K
可選軌道式



OK 21732 36000
L580 W60 H300mm 線長1000mm
內含LED 5W x 3快拆式光源
鋁材烤漆
可選3000K/4000K



OK 21741

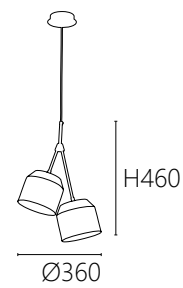

OK 21741 27000
 Ø360 H460mm 線長1500mm
 E27 x 2另計
 鋼材

OK 21742

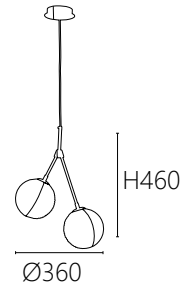

OK 21742 30000
 Ø360 H460mm 線長1500mm
 G9 x 2另計
 鋼材 玻璃



OK 21751

OK 21752

OK 21753

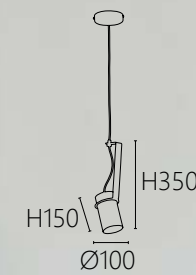

OK 21751~3 21000
 Ø100 H350mm 線長1500mm
 E27 x 1 另計
 鋼材 鋁材



OK 21761



OK 21762



OK 21763

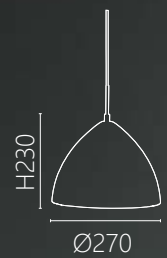

OK 21761 26000
Ø270 H230mm 線長1000mm
E27 x 1另計
陶瓷烤漆

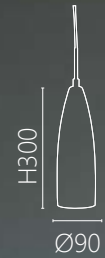

OK 21762 21000
Ø90 H300mm 線長1000mm
E14 x 1另計
陶瓷烤漆



OK 21763 23000
Ø170 H220mm 線長1000mm
E27 x 1另計
陶瓷烤漆



OK 21771



OK 21772

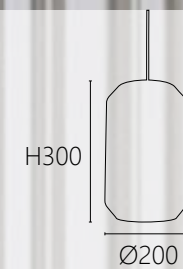

OK 21771 32000
Ø200 H300mm 線長1000mm
E27 x 1另計
玻璃

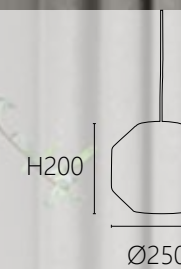

OK 21772 32000
Ø250 H200mm 線長1000mm
E27 x 1另計
玻璃



OK 21781

OK 21782

OK 21783



OK 21781~3 26000
 Ø210 H210mm 線長1000mm
 E27 x 1另計
 玻璃 鋼材



OK 21791

OK 21792

OK 21793



OK 21791 23800
 Ø200 H500mm 線長1000mm
 G9 x 1另計
 鋼材烤漆 玻璃



OK 21792 21500
 Ø170 H400mm 線長1000mm
 G9 x 1另計
 鋼材烤漆 玻璃



OK 21793 19300
 Ø140 H300mm 線長1000mm
 G9 x 1另計
 鋼材烤漆 玻璃



OK 21802

OK 21801

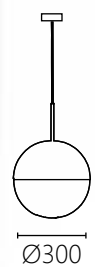

OK 21801 52000
 Ø300 H300mm 線長1000mm
 E27 x 1另計
 全銅 玻璃

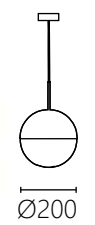

OK 21802 38000
 Ø200 H200mm 線長1000mm
 E27 x 1另計
 全銅 玻璃



OK 21811 50000
 Ø250 H450mm 線長1500mm
 E27 x 1另計
 鋼材電鍍



OK 21822

OK 21821

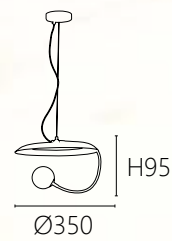

OK 21821/2 30000
 Ø350 H95mm 線長1500mm
 G9 x 1另計
 鋼材 可磁吸球體



OK 21831

OK 21832



OK 21831/2 26000
 Ø380 H80mm 線長1500mm
 G9 x 1 另計
 鋼材 可隨意調整軟管



OK 21841



OK 21842



OK 21841/2 25000
Ø410 H450mm 線長1000mm
E27 x 1 另計
鋼材烤漆



OK 21851



OK 21852



OK 21851 36000
Ø450 H210mm 線長1000mm
E27 x 1 另計
鋼材烤漆

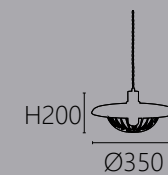

OK 21852 30000
Ø350 H200mm 線長1000mm
E27 x 1 另計
鋼材烤漆



OK 21861

OK 21862

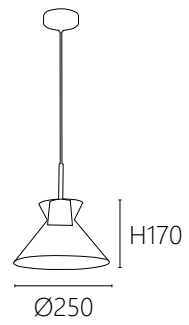

OK 21861 16000
 Ø250 H170mm 線長1500mm
 E27 x 1 另計
 手工玻璃 原木

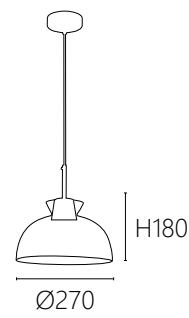

OK 21862 18000
 Ø270 H180mm 線長1500mm
 E27 x 1 另計
 手工玻璃 原木



OK 21871

OK 21872



OK 21871/2 30000
 Ø300 H250mm 線長1500mm
 內含LED 5W 3000K
 鋼材 玻璃



OK 21881



OK 21882



H350

OK 21881/2 18000
 Ø300 H350mm 線長1000mm
 E27 x 1 另計
 鋼材烤漆

Ø300



H500

OK 21891 70000
 Ø400 H500mm 線長1000mm
 內含LED 15W 3000K
 鋼材烤漆 壓克力

Ø400



OK 21901



OK 21902



OK 21903



OK 21904

OK 21901 黑/白 2000
 Ø100 H25mm
 鋼材烤漆

OK 21902 黑/白 7000
 Ø50 H80mm
 鋁材烤漆

OK 21903 黑/白 3500
 Ø24 H80mm
 鋁材烤漆

OK 21904 黑/白 2000
 Ø25 H28mm
 鋁材烤漆



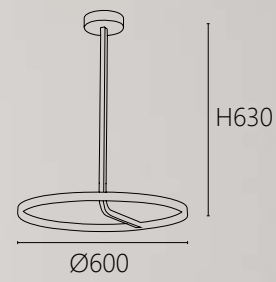

OK 21921 38000
Ø600 H630mm
內含LED 30W 4000K
鋼材烤漆 壓克力

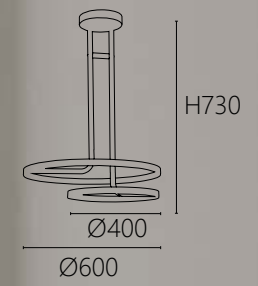

OK 21931 72000
Ø400+Ø600 H730mm
內含LED 45W 4000K
鋼材烤漆 壓克力

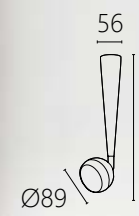

OK 21941 20000
H350 Ø89 W56 H350mm
內含LED 12W 3000K
鋁材 透鏡玻璃



OK 21942 28000
H550 Ø89 W56 H550mm
內含LED 12W 3000K
鋁材 透鏡玻璃

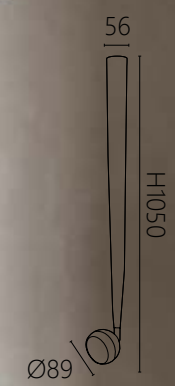

OK 21951 36000
H1050 Ø89 W56 H1050mm
內含LED 12W 3000K
鋁材 透鏡玻璃



OK 21961



OK 21962

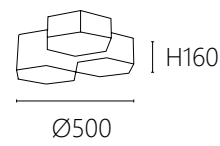

OK 21961 45000
 Ø500 H160mm
 附LED 42W 3段光色
 鋼材烤漆 壓克力



OK 21962 45000
 Ø600 H100mm
 附LED 50W 3段光色
 鋼材烤漆 壓克力

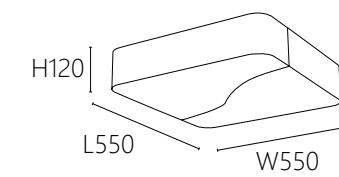

OK 21971 48000
 W550 H120mm
 附LED 50W 3段光色
 鋼材烤漆 壓克力



OK 21981



OK 21982

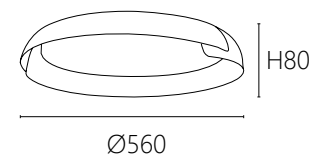

OK 21981/2 38000
 Ø560 H80mm
 附LED 36W x 2 3段光色
 鋼材烤漆 壓克力

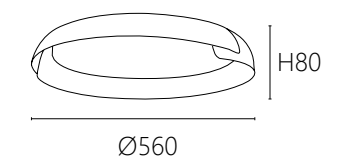

OK 21991 45000
 Ø560 H80mm
 附LED 36W x 2 3段光色
 鋼材烤漆 壓克力



OK 22001



OK 22002

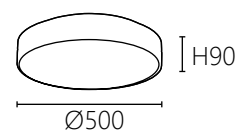

OK 22001/2 32000
 Ø500 H90mm
 附LED 36W 3段光色
 鋼材烤漆 壓克力

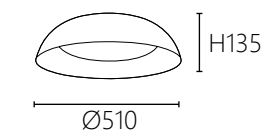

OK 22011 38000
 Ø510 H135mm
 附LED 36W 3段光色
 鋼材烤漆 壓克力

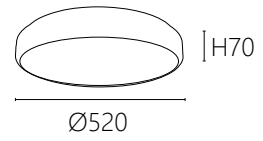

OK 22021

OK 22021/2 20000
Ø520 H70mm
附LED 45W 三段式光色
鋼材烤漆 壓克力



OK 22022



OK 22023

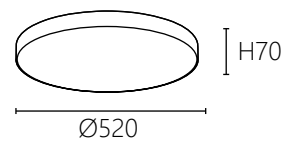

OK 22023/4 20000
Ø520 H70mm
內附LED 45W 三段式光色
鋼材烤漆 壓克力



OK 22024



OK 22032

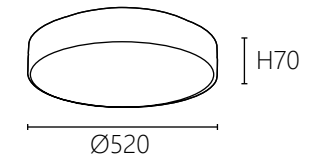

OK 22031/2 20000
Ø520 H70mm
附LED 45W 三段式光色
鋼材烤漆 壓克力



OK 22031



OK 22034



OK 22033

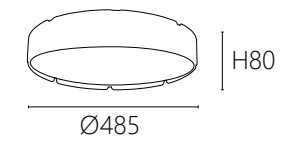

OK 22033/4 20000
Ø485 H80mm
附LED 45W 三段式光色
鋼材烤漆 壓克力

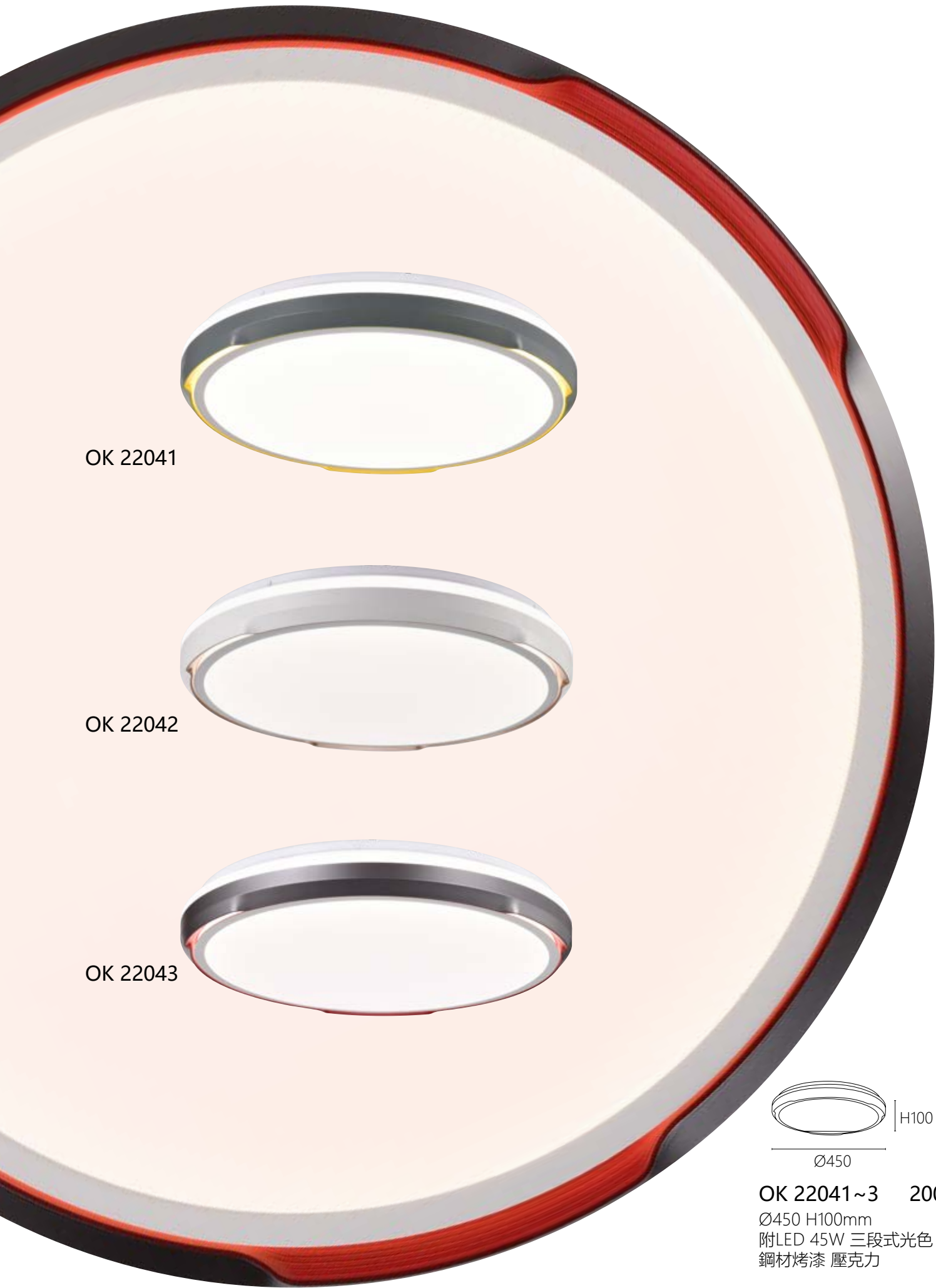

OK 22041

OK 22042

OK 22043

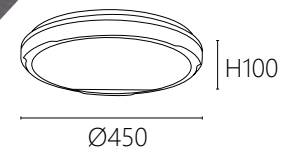

OK 22041~3 20000
 Ø450 H100mm
 附LED 45W 三段式光色
 鋼材烤漆 壓克力



OK 22051

OK 22052

OK 22053

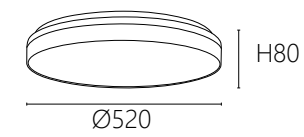

OK 22051~3 21000
 Ø500 H80mm
 附LED 45W 三段式光色
 鋼材烤漆 壓克力



OK 22061



OK 22062



OK 22063

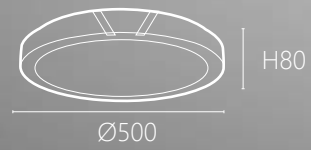

OK 22061~3 21000
Ø500 H80mm
附LED 45W 三段式光色
鋼材烤漆 壓克力

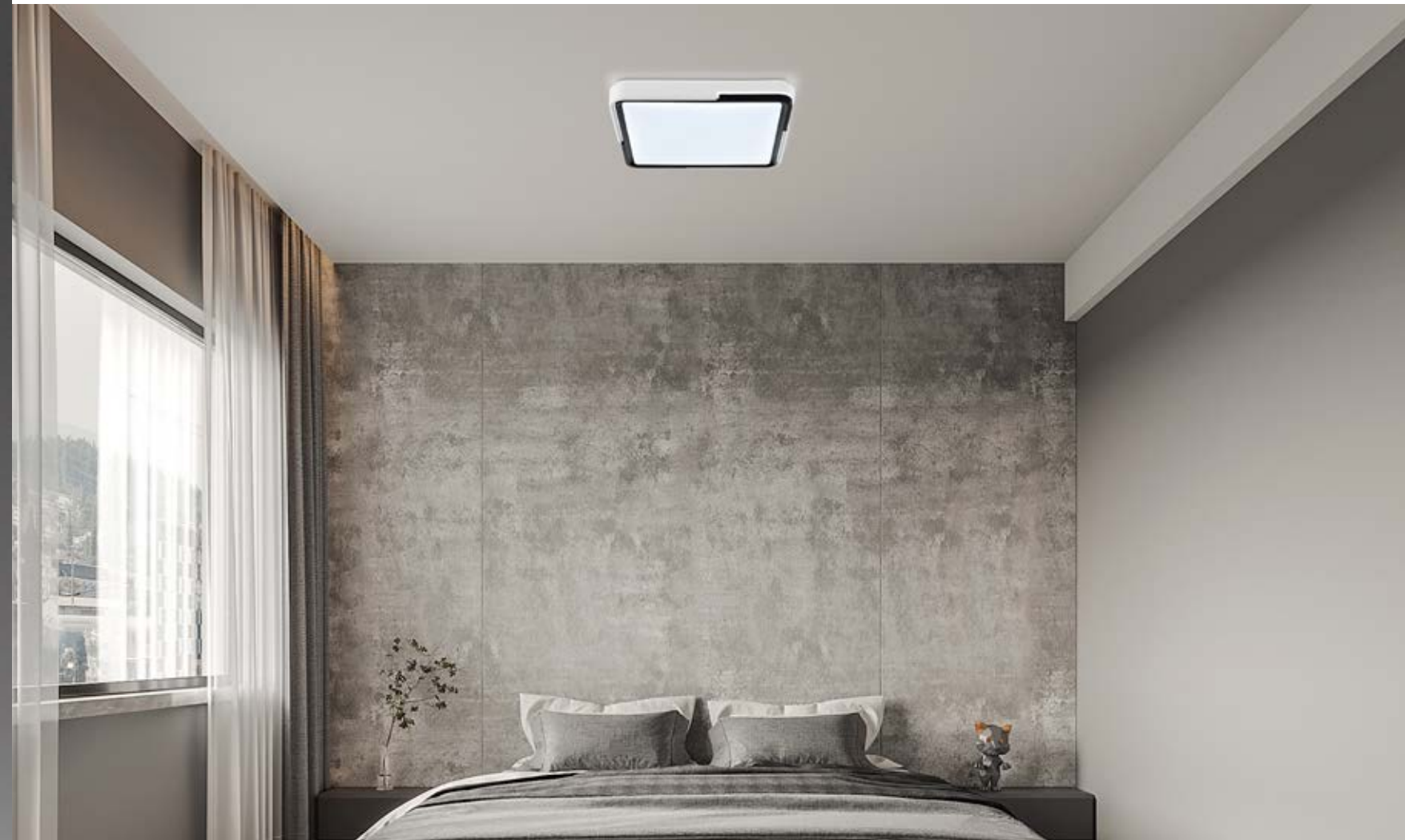

OK 22071



OK 22072



OK 22073

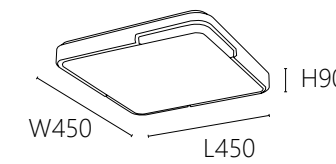

OK 22071~3 22000
L450 W450 H90mm
附LED 45W 三段式光色
鋼材烤漆 壓克力



Dimensions

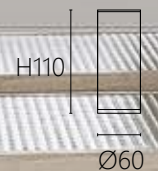

OK 22091 黑/白 8280
 OK 22091 電鍍金/玫瑰金 9500
 Ø60 H110mm
 內附LED MR16 6W x 1
 鋁材烤漆
 可選3000K/4000K



OK 22092 黑/白 10000
 OK 22092 電鍍金/玫瑰金 11000
 Ø60 H200mm
 內附LED MR16 6W x 1
 鋁材烤漆
 可選3000K/4000K

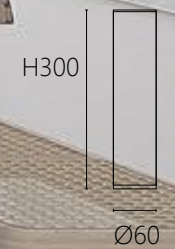

OK 22093 黑/白 12000
 OK 22093 電鍍金/玫瑰金 15000
 Ø60 H300mm
 內附LED MR16 6W x 1
 鋁材烤漆
 可選3000K/4000K



OK 22101

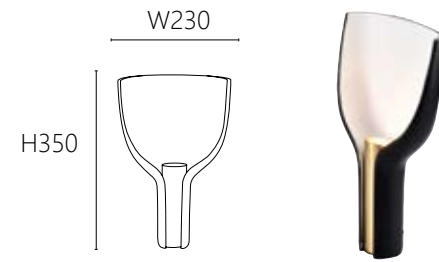

OK 22101 45000
W230 H350mm 線長1500mm
GU10 x 1另計
鋼材

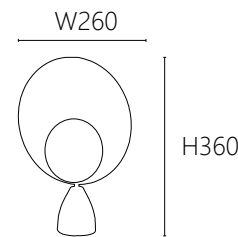

OK 22102 26000
W260 H360mm 線長1500mm
G9 x 1另計
鋼材



OK 22102

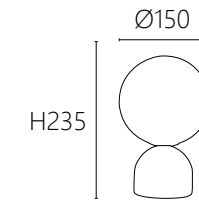

OK 22111 20000
Ø150 H235mm 線長1000mm
G9 x 1另計
大理石 玻璃

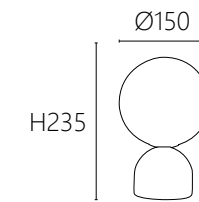

OK 22112 20000
Ø150 H235mm 線長1000mm
G9 x 1另計
大理石 玻璃

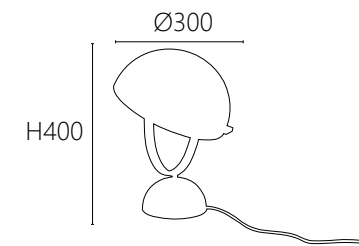

OK 22113 32000
Ø300 H400mm 線長1000mm
E27 x 1另計
鋼材烤漆





OK 22121



OK 22121 40000
Ø280 H240mm 線長1500mm
E27 x 1另計
鋼材 玻璃



OK 22122 60000
Ø280 H470mm 線長1000mm
G9 x 1另計
鋼材 玻璃



OK 22122

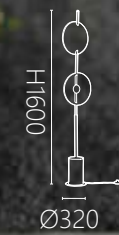

OK 22131 98000
Ø320 H1600mm 線長1000mm
附LED 4W x 2 3000K
鋼材 塑質





OK 22141



OK 22142



H1450

Ø400

OK 22141 108000
 OK 22142 82000
 Ø400 H1450mm
 內附LED 5W 三段光色
 鋼材電鍍 大理石



OK 22151

OK 22152



H1700

Ø300

OK 22151/2 62000
 Ø300 H1700mm
 E27 x 1 另計
 鋼材 實木 大理石
 內置無線充電 & USB接口



(無線充電)

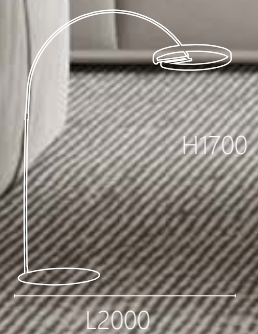

OK 22161 132000
 L2000 H1700mm
 線長1500mm
 內附LED 40W 3000K
 鋼材



OK 22171 96000
 L1150 H1650mm
 線長1500mm
 內附LED 9W 3000K
 鋼材



OK 22181 112000
 L600 W300 H1700mm
 線長1500mm
 內附LED 30W 全電壓 3000K
 鋼材 鋁材



OK 22191 112000
 L600 W300 H1700mm
 線長1500mm
 內附LED 30W 全電壓 3000K
 鋼材 鋁材



LED COMMERCIAL LIGHTING SERIES

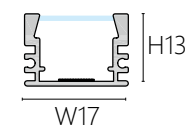

(配件圖)

JBR 20011

功率: 12W/米
光色: 3000K/ 4000K/ 6000K
尺寸: W17 H13mm
電壓: DC 24V
可選透明面罩/霧面面罩
裁切尺寸 30公分以上

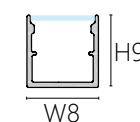

(配件圖)

JBR 20012

功率: 12W/米
光色: 3000K/ 4000K/ 6000K
尺寸: W8 H9mm
電壓: DC 24V
霧面面罩
裁切尺寸 30公分以上

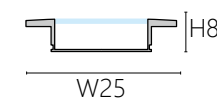

(配件圖)

JBR 20013

功率: 12W/米
光色: 3000K/ 4000K/ 6000K
尺寸: W25 H8mm
電壓: DC 24V
可選透明罩/霧面面罩
裁切尺寸 30公分以上

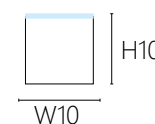
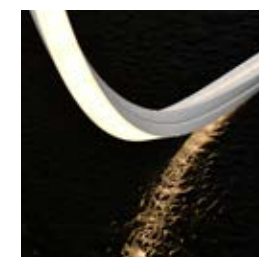

(明緯驅動)

JBR 20014

光源: SMD 2835
功率: 12W/米
光色: 3000K/ 4000K/ 6000K
電壓: DC 24V
5米/捲 (不材切)
附卡扣 x 8 堵頭 x 4

JBR 20015

光源: SMD 2835
功率: 12W/米
光色: 3000K/ 4000K/ 6000K
電壓: DC 24V
120燈珠/米

CEILING LIGHT

led commercial lighting series



JBR 20022

JBR 20021

Dimensions

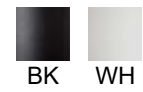
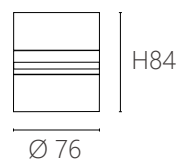

Item No.	Chip	Watts	C.C.T	CRI	Lumens		Size (mm)	
JBR 20021	PHILIPS	8W	3000K 4000K 6000K	90+	848Lm	--	Ø76 H84	--°
JBR 20022	PHILIPS	8W	3000K 4000K 6000K	90+	848Lm	--	Ø76 H84	--°



JBR 20032

JBR 20031

Dimensions

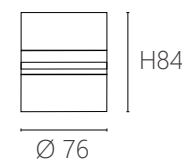

Item No.	Chip	Watts	C.C.T	CRI	Lumens		Size (mm)	
JBR 20031	PHILIPS	8W	3000K 4000K 6000K	90+	848Lm	--	Ø76 H84	24°
JBR 20032	PHILIPS	8W	3000K 4000K 6000K	90+	848Lm	--	Ø76 H84	24°

CEILING LIGHT

led commercial lighting series



可訂製 CRI 97

Dimensions

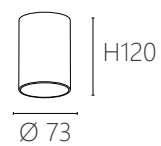

JBR 20041B/W



JBR 20042B/W



JBR 20043B/W

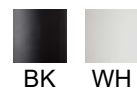

Item No.	Chip	Watts	C.C.T	CRI	Lumens		Size (mm)	
JBR 20041B/W	PHILIPS	12W	3000K 4000K 6000K	90+	1272Lm	--	Ø73 H120	45°
JBR 20042B/W	PHILIPS	12W	3000K 4000K 6000K	90+	1272Lm	--	Ø73 H120	45°
JBR 20043B/W	PHILIPS	12W	3000K 4000K 6000K	90+	1272Lm	--	Ø73 H120	45°



Dimensions

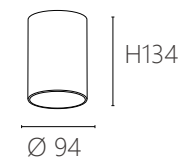

JBR 20051B/W



JBR 20052B/W



JBR 20053B/W

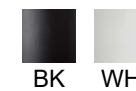

Item No.	Chip	Watts	C.C.T	CRI	Lumens		Size (mm)	
JBR 20051B/W	PHILIPS	18W	3000K 4000K 6000K	90+	1908Lm	--	Ø94 H134	45°
JBR 20052B/W	PHILIPS	18W	3000K 4000K 6000K	90+	1908Lm	--	Ø94 H134	45°
JBR 20053B/W	PHILIPS	18W	3000K 4000K 6000K	90+	1908Lm	--	Ø94 H134	45°

CEILING LIGHT

led commercial lighting series



JBR 20061B/W



JBR 20062B/W

Dimensions

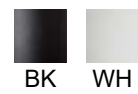
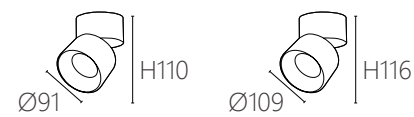

Item No.	Chip	Watts	C.C.T	CRI	Lumens	Size (mm)	▲
JBR 20061B/W	PHILIPS	12W	3000K 4000K 6000K	90+	1272Lm	Ø91 H110	30°
JBR 20062B/W	PHILIPS	20W	3000K 4000K 6000K	90+	2120Lm	Ø109 H116	30°

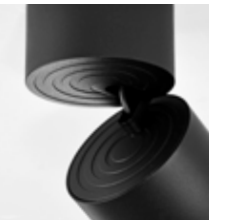

(可單獨更換模組)



JBR 20071

JBR 20072

Dimensions



Item No.	Chip	Watts	C.C.T	CRI	Lumens	🌀	Size (mm)
JBR 20071	三安	8W	3000K 4000K	80+	880Lm	--	Ø82 H98
JBR 20072	三安	8W	3000K 4000K	80+	880Lm	--	Ø82 H98

CEILING LIGHT

led commercial lighting series



Dimensions

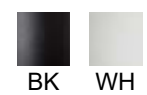
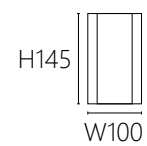

Item No.	Chip	Watts	C.C.T	CRI	Lumens	Size (mm)	▲
JBR 20081B	PHILIPS	12W	3000K 4000K 6000K	90+	1272Lm	Ø100 H145	30°
JBR 20082W	PHILIPS	12W	3000K 4000K 6000K	90+	1272Lm	Ø100 H145	30°

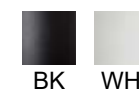

Item No.	Chip	Watts	C.C.T	CRI	Lumens	▲	Size (mm)	▲
JBR 20091	OSRAM	12W	3000K 4000K 6000K	80+	1296Lm	--	Ø116 H82	--
JBR 20092	OSRAM	12W	3000K 4000K 6000K	80+	1296Lm	--	Ø116 H82	--
JBR 20093W/B	PHILIPS	6W	3000K 4000K 6000K	90+	684Lm	--	Ø65 H71	36°
JBR 20094W/B	PHILIPS	10W	3000K 4000K 6000K	90+	1060Lm	--	Ø85 H81	36°

CEILING LIGHT

led commercial lighting series



Dimensions

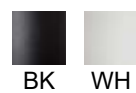

Item No.	Chip	Watts	C.C.T	CRI	Lumens		Size (mm)	
JBR 20101	OSRAM	18W	3000K 4000K 6000K	80+	1944Lm	--	Ø134 H68	--
JBR 20102	OSRAM	18W	3000K 4000K 6000K	80+	1944Lm	--	Ø134 H68	--
JBR 20103	OSRAM	24W	3000K 4000K 6000K	80+	2592Lm	--	Ø163 H73	--
JBR 20104	OSRAM	24W	3000K 4000K 6000K	80+	2592Lm	--	Ø163 H73	--

Dimensions

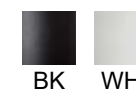

Item No.	Chip	Watts	C.C.T	CRI	Lumens		Size (mm)	
JBR 20111	PHILIPS	12W	3000K 4000K 6000K	90+	1272Lm	--	L81 W81 H100	--
JBR 20112	PHILIPS	12W	3000K 4000K 6000K	90+	1272Lm	--	L81 W81 H100	--
JBR 20113	PHILIPS	12Wx2	3000K 4000K 6000K	90+	2544Lm	--	L155 W81 H100	--
JBR 20114	PHILIPS	12Wx2	3000K 4000K 6000K	90+	2544Lm	--	L155 W81 H100	--

CEILING LIGHT

led commercial lighting series



JBR 20132

JBR 20131

Dimensions

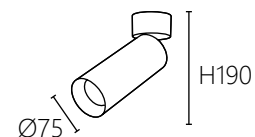
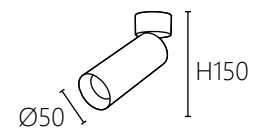

JBR 20121
(配置MR16)

JBR 20122
(配置MR16)

JBR 20123

JBR 20124



Item No.	Chip	Watts	C.C.T	CRI	Lumens		Size (mm)	
JBR 20121	PHILIPS	6W	3000K 4000K 6000K	90+	648Lm	--	Ø50 H150	25°
JBR 20122	PHILIPS	6W	3000K 4000K 6000K	90+	648Lm	--	Ø50 H150	25°
JBR 20123	PHILIPS	12W	3000K 4000K 6000K	90+	1272Lm	--	Ø75 H190	30°
JBR 20124	PHILIPS	12W	3000K 4000K 6000K	90+	1272Lm	--	Ø75 H190	30°

Dimensions

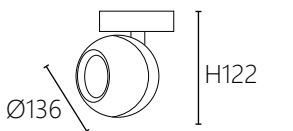

Item No.	Chip	Watts	C.C.T	CRI	Lumens		Size (mm)	
JBR 20131	PHILIPS	12W	3000K 4000K 6000K	90+	1272Lm	--	Ø136 H122	36°
JBR 20132	PHILIPS	12W	3000K 4000K 6000K	90+	1272Lm	--	Ø136 H122	36°

CEILING LIGHT

led commercial lighting series



(可單獨更換模組)



Dimensions

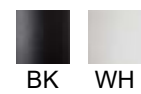
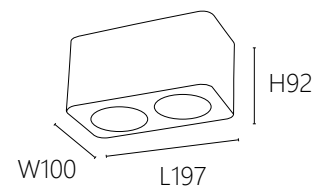

JBR 20141



JBR 20142

Item No.	Chip	Watts	C.C.T	CRI	Lumens		Size (mm)
JBR 20141	三安	16W	3000K 4000K	80+	1760Lm	--	L197 W100 H92
JBR 20142	三安	16W	3000K 4000K	80+	1760Lm	--	L197 W100 H92



JBR 20151



JBR 20152

(可單獨更換模組)

Dimensions

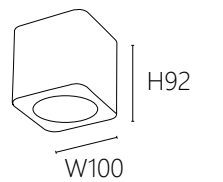

Item No.	Chip	Watts	C.C.T	CRI	Lumens		Size (mm)
JBR 20151	三安	8W	3000K 4000K	80+	880Lm	--	L100 W100 H92
JBR 20152	三安	8W	3000K 4000K	80+	880Lm	--	L100 W100 H92

CEILING LIGHT

led commercial lighting series



JBR 20161

JBR 20162



JBR 20171

JBR 20172

Dimensions

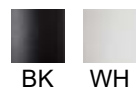
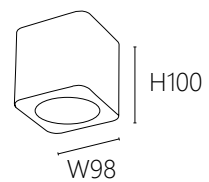

Item No.	Chip	Watts	C.C.T	CRI	Lumens		Size (mm)	
JBR 20161	PHILIPS	12W	3000K 4000K 6000K	90+	1272Lm	--	W98 H100	30°
JBR 20162	PHILIPS	12W	3000K 4000K 6000K	90+	1272Lm	--	W98 H100	30°

Dimensions

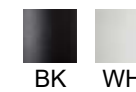
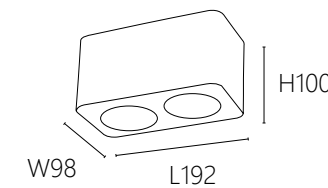

Item No.	Chip	Watts	C.C.T	CRI	Lumens		Size (mm)	
JBR 20171	PHILIPS	24W	3000K 4000K 6000K	90+	2544Lm	--	L192 W98 H100	30°
JBR 20172	PHILIPS	24W	3000K 4000K 6000K	90+	2544Lm	--	L192 W98 H100	30°

CEILING LIGHT

led commercial lighting series



JBR 20191B
JBR 20191W

JBR 20192B
JBR 20192W

Dimensions

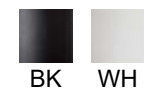
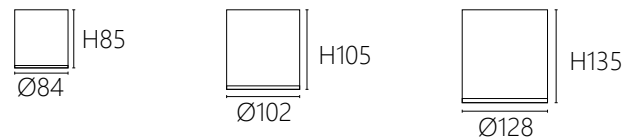

Item No.	Chip	Watts	C.C.T	CRI	Lumens		Size (mm)	
JBR 20181B/W	PHILIPS	12W	3000K 4000K 6000K	90+	1272Lm	--	Ø84 H85	30°
JBR 20182B/W	PHILIPS	16W	3000K 4000K 6000K	90+	1696Lm	--	Ø102 H105	30°
JBR 20183B/W	PHILIPS	20W	3000K 4000K 6000K	90+	2120Lm	--	Ø128 H135	30°

Dimensions

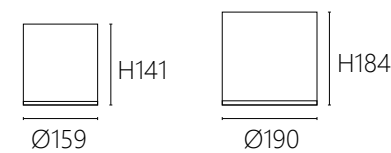

Item No.	Chip	Watts	C.C.T	CRI	Lumens		Size (mm)	
JBR 20191B/W	PHILIPS	30W	3000K 4000K 6000K	90+	3180Lm	--	Ø159 H141	30°
JBR 20192B/W	PHILIPS	45W	3000K 4000K 6000K	90+	4770Lm	--	Ø190 H184	30°

配置PHILIPS變壓器

DOWN LIGHT

led commercial lighting series



Dimensions



JBR 20211

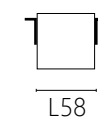

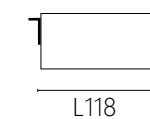

JBR 20212

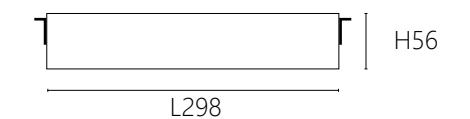

JBR 20213



Item No.	Chip	Watts	C.C.T	CRI	Lumens		Size (mm)	
JBR 20211	PHILIPS	5W	3000K 4000K 6000K	90+	530Lm	L60 W60	L58 W58 H56	24°
JBR 20212	PHILIPS	10W	3000K 4000K 6000K	90+	1060Lm	L120 W60	L118 W58 H56	24°
JBR 20213	PHILIPS	25W	3000K 4000K 6000K	90+	2650Lm	L300 W60	L298 W58 H56	24°

DOWN LIGHT

led commercial lighting series



旋轉式面蓋
不易鬆脫 易拆裝
(取代傳統固定鐵環)



JBR 20231
尺寸 : L98 W98 H100mm
開孔 : L100 W100mm
(可訂製白色)



JBR 20232
尺寸 : L198 W98 H100mm
開孔 : L200 W100mm
(可訂製白色)



JBR 20233
尺寸 : L298 W98 H100mm
開孔 : L300 W100mm
(可訂製白色)



JBR 20221
尺寸 : L83 W83 H80mm
開孔 : L85 W85mm
(可訂製白色)



JBR 20222
尺寸 : L168 W83 H100mm
開孔 : L170 W 85mm
(可訂製白色)



JBR 20223
尺寸 : L248 W83 H100mm
開孔 : L250 W85mm
(可訂製白色)



JBR 20234
尺寸 : L130 W130 H100mm
開孔 : L110 W110mm



JBR 20235
尺寸 : L230 W130 H100mm
開孔 : L210 W110mm



JBR 20236
尺寸 : L330 W130 H100mm
開孔 : L310 W110mm



JBR 20224
尺寸 : L111 W111 H80mm
開孔 : L95 W95mm



JBR 20225
尺寸 : L197 W111 H100mm
開孔 : L180 W95mm



JBR 20226
尺寸 : L276 W111 H100mm
開孔 : L260 W95mm



M101
光源 : **OSRAM**
尺寸 : Ø49 H34mm
功率 : 5W
通光量 : 540 Lm
光色 : 3000K / 4000K / 6000K
材質 : 鋁材
演色性 : CRI > 80
可選黑殼 / 白殼



MR16
光源 : **PHILIPS**
尺寸 : Ø49 H61mm
功率 : 6W
通光量 : 636 Lm
光色 : 3000K / 4000K / 6000K
材質 : 鋁材
發光角度 : 25°
演色性 : CRI > 90
可選槍灰 / 白殼



M65 可訂製 CRI 97
光源 : **PHILIPS**
尺寸 : Ø50 H65mm
功率 : 8W
通光量 : 848 Lm
光色 : 3000K / 4000K / 6000K
材質 : 壓鑄鋁
發光角度 : 24°/36°
演色性 : CRI > 90



M90 可訂製 CRI 97
光源 : **PHILIPS**
尺寸 : Ø50 H90mm
功率 : 12W
通光量 : 1272 Lm
光色 : 3000K / 4000K / 6000K
材質 : 壓鑄鋁
發光角度 : 24°/36°
演色性 : CRI > 90

AR80 DOWN LIGHT

led commercial lighting series



AR111 DOWN LIGHT

led commercial lighting series



JBR 20241
尺寸 : L118 W118 H118mm
開孔 : L120 W120mm



JBR 20242
尺寸 : L238 W118 H118mm
開孔 : L240 W120mm



JBR 20243
尺寸 : L358 W118 H118mm
開孔 : L340 W120mm



JBR 20251
尺寸 : L148 W148 H100mm
開孔 : L150 W150mm



JBR 20252
尺寸 : L298 W148 H100mm
開孔 : L300 W150mm



JBR 20253
尺寸 : L448 W148 H100mm
開孔 : L450 W150mm



JBR 20244
尺寸 : L150 W150 H120mm
開孔 : L130 W130mm



JBR 20245
尺寸 : L270 W150 H120mm
開孔 : L250 W130mm



JBR 20246
尺寸 : L390 W150 H120mm
開孔 : L350 W130mm



JBR 20254
尺寸 : L176 W176 H100mm
開孔 : L160 W160mm



JBR 20255
尺寸 : L327 W176 H100mm
開孔 : L310 W160mm



JBR 20256
尺寸 : L477 W176 H100mm
開孔 : L460 W160mm



JBR AR80W
光源 : PHILIPS
功率 : 15W
流明 : 1680Lm CRI:90
色溫 : 3000K/4000K/6000K
尺寸 : Ø75xH78mm
材質 : 壓鑄鋁



JBR AR80B
光源 : PHILIPS
功率 : 15W
流明 : 1680Lm CRI:90
色溫 : 3000K/4000K/6000K
尺寸 : Ø75xH78mm
材質 : 壓鑄鋁



JA 12238 B/W
光源 : PHILIPS
尺寸 : Ø111 H50mm
功率 : 12W
通光量 : 1272 Lm
光色 : 3000K/ 4000K/ 6000K
材質 : 鋁材
發光角度 : 36°
演色性 : CRI>90
可選黑殼 / 白殼



JA 1662 B/W
光源 : PHILIPS
尺寸 : Ø111 H50mm
功率 : 16W
通光量 : 1696 Lm
光色 : 3000K/ 4000K/ 6000K
材質 : 鋁材
發光角度 : 24°
演色性 : CRI>90
可選灰殼 / 白殼

DOWN LIGHT

led commercial lighting series



(前置式)



JBR 20261
尺寸 : L110 W110 H25mm
開孔 : L100 W100mm



JBR 20262
尺寸 : L196 W110 H25mm
開孔 : L185 W100mm



JBR 20263
尺寸 : L280 W110 H25mm
開孔 : L270 W100mm



JBR 20264
尺寸 : L110 W110 H25mm
開孔 : L100 W100mm



JBR 20265
尺寸 : L196 W110 H25mm
開孔 : L185 W100mm



JBR 20266
尺寸 : L280 W110 H25mm
開孔 : L270 W100mm

(後置式)



JBR 20271
尺寸 : L110 W110 H25mm
開孔 : L100 W100mm



JBR 20272
尺寸 : L196 W110 H25mm
開孔 : L185 W100mm



JBR 20273
尺寸 : L280 W110 H25mm
開孔 : L270 W100mm



JBR 20274
尺寸 : L110 W110 H25mm
開孔 : L100 W100mm



JBR 20275
尺寸 : L196 W110 H25mm
開孔 : L185 W100mm



JBR 20276
尺寸 : L280 W110 H25mm
開孔 : L270 W100mm



M101
光源 : **OSRAM**
尺寸 : Ø49 H34mm
功率 : 5W
通光量 : 540 Lm
光色 : 3000K / 4000K / 6000K
材質 : 鋁材
演色性 : CRI > 80
可選黑殼 / 白殼



MR90
光源 : **PHILIPS**
尺寸 : Ø49 H61mm
功率 : 6W
通光量 : 636 Lm
光色 : 3000K / 4000K / 6000K
材質 : 壓鑄鋁
發光角度 : 25°
演色性 : CRI > 90
可選黑殼 / 白殼



M65 可訂製 CRI 97
光源 : **PHILIPS**
尺寸 : Ø50 H65mm
功率 : 8W
通光量 : 848 Lm
光色 : 3000K / 4000K / 6000K
材質 : 壓鑄鋁
發光角度 : 24°/36°
演色性 : CRI > 90



M90 可訂製 CRI 97
光源 : **PHILIPS**
尺寸 : Ø50 H90mm
功率 : 12W
通光量 : 1272 Lm
光色 : 3000K / 4000K / 6000K
材質 : 壓鑄鋁
發光角度 : 24°/36°
演色性 : CRI > 90

TRACK LIGHT

led commercial lighting series



JBR 20291

JBR 20292

Dimensions

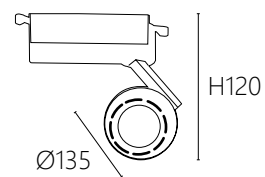

JBR 20281



JBR 20282



Item No.	Chip	Watts	C.C.T	CRI	Lumens	Size (mm)	▲
JBR 20281	PHILIPS	8W	3000K 4000K 6000K	90+	848Lm	Ø135 H120	36°
JBR 20281	PHILIPS	8W	3000K 4000K 6000K	90+	848Lm	Ø135 H120	36°

Dimensions

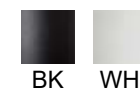
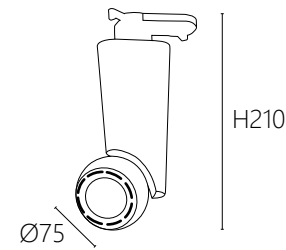

Item No.	Chip	Watts	C.C.T	CRI	Lumens	Size (mm)	▲
JBR 20291	PHILIPS	8W	3000K 4000K 6000K	90+	848Lm	Ø75 H210mm	36°
JBR 20292	PHILIPS	8W	3000K 4000K 6000K	90+	848Lm	Ø75 H210mm	36°

TRACK LIGHT

led commercial lighting series



Dimensions

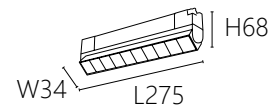

JBR 20301



JBR 20302



Item No.	Chip	Watts	C.C.T	CRI	Lumens	Size (mm)	▲
JBR 20301	OSRAM	10W	3000K 4000K	80+	1080Lm	L275 W34 H68	30°
JBR 20302	OSRAM	10W	3000K 4000K	80+	1080Lm	L275 W34 H68	30°

此系列為二線式軌道燈



JBR 20311



JBR 20312

Dimensions

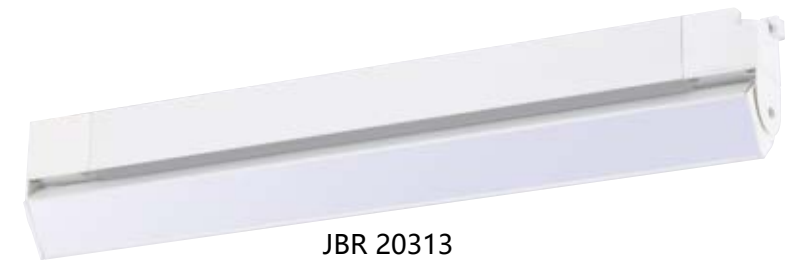
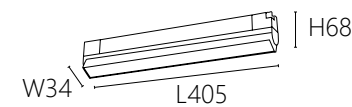
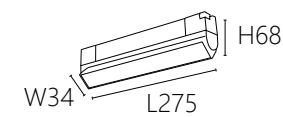

JBR 20313



JBR 20314

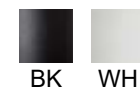

Item No.	Chip	Watts	C.C.T	CRI	Lumens	☞	Size (mm)
JBR 20311	OSRAM	10W	3000K 4000K	80+	1080Lm	--	L275 W34 H68
JBR 20312	OSRAM	10W	3000K 4000K	80+	1080Lm	--	L275 W34 H68
JBR 20313	OSRAM	15W	3000K 4000K	80+	1620Lm	--	L405 W34 H68
JBR 20314	OSRAM	15W	3000K 4000K	80+	1620Lm	--	L405 W34 H68

此系列為二線式軌道燈

TRACK LIGHT

led commercial lighting series



Dimensions

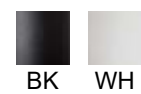
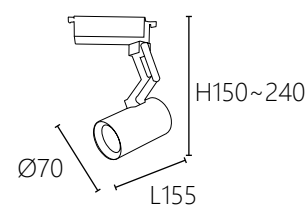

JBR 20321



JBR 20322

Item No.	Chip	Watts	C.C.T	CRI	Lumens	Size (mm)	▲
JBR 20321	PHILIPS	18W	3000K 4000K 6000K	90+	1908Lm	Ø70 L155	36°
JBR 20322	PHILIPS	18W	3000K 4000K 6000K	90+	1908Lm	Ø70 L155	36°



Dimensions

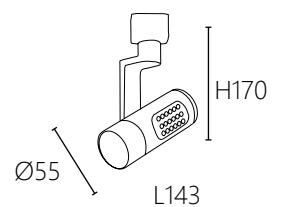

JBR 20331



JBR 20332

Item No.	Chip	Watts	C.C.T	CRI	Lumens	▲	Size (mm)	▲
JBR 20331	PHILIPS	8W	3000K 4000K 6000K	90+	848Lm	--	Ø55 L143 H170	36°
JBR 20332	PHILIPS	8W	3000K 4000K 6000K	90+	848Lm	--	Ø55 L143 H170	36°

TRACK LIGHT

led commercial lighting series



Dimensions

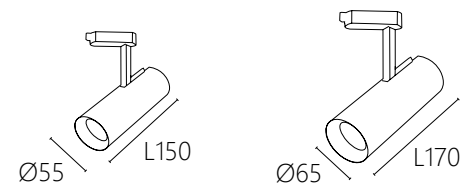

JBR 20341B/W



JBR 20342B/W

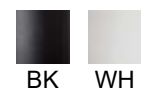

Item No.	Chip	Watts	C.C.T	CRI	Lumens	Size (mm)	▲
JBR 20341B/W	PHILIPS	15W	3000K 4000K 6000K	90+	1590Lm	Ø55 L150	24 / 60°
JBR 20342B/W	PHILIPS	20W	3000K 4000K 6000K	90+	2120Lm	Ø65 L170	24 / 60°



Dimensions

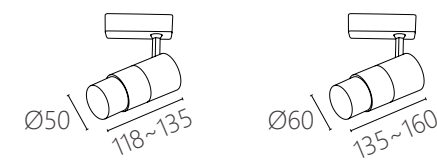

JBR 20351B/W
可訂製 CRI 97



JBR 20352B/W
可訂製 CRI 97

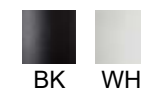

Item No.	Chip	Watts	C.C.T	CRI	Lumens	Size (mm)	▲
JBR 20351B/W	PHILIPS	6W	3000K 4000K 6000K	90+	626Lm	Ø50 L118~135	15~60°
JBR 20352B/W	PHILIPS	12W	3000K 4000K 6000K	90+	1272Lm	Ø60 L135~160	15~60°

TRACK LIGHT

led commercial lighting series



可訂製 CRI 97

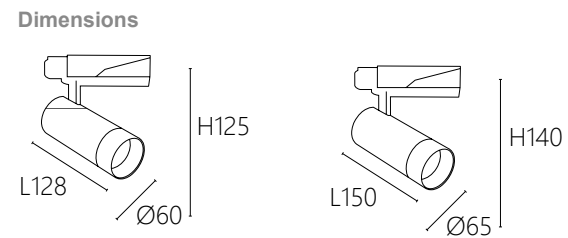

JBR 20361B/W



JBR 20362B/W

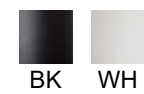

Item No.	Chip	Watts	C.C.T	CRI	Lumens	Size (mm)	▲
JBR 20361B/W	PHILIPS	10W	3000K 4000K 6000K	90+	1060Lm	Ø60 L128 H125	30°
JBR 20362B/W	PHILIPS	15W	3000K 4000K 6000K	90+	1590Lm	Ø65 L150 H140	30°



JBR 20371W



JBR 20371B



JBR 20372W



JBR 20372B

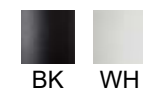

Item No.	Chip	Watts	C.C.T	CRI	Lumens	Size (mm)	▲
JBR 20371B/W	PHILIPS	10W	3000K 4000K 6000K	90+	1060Lm	Ø63 L105 H140	30°
JBR 20372B/W	PHILIPS	16W	3000K 4000K 6000K	90+	1696Lm	Ø75 L127 H182	30°

TRACK LIGHT

led commercial lighting series

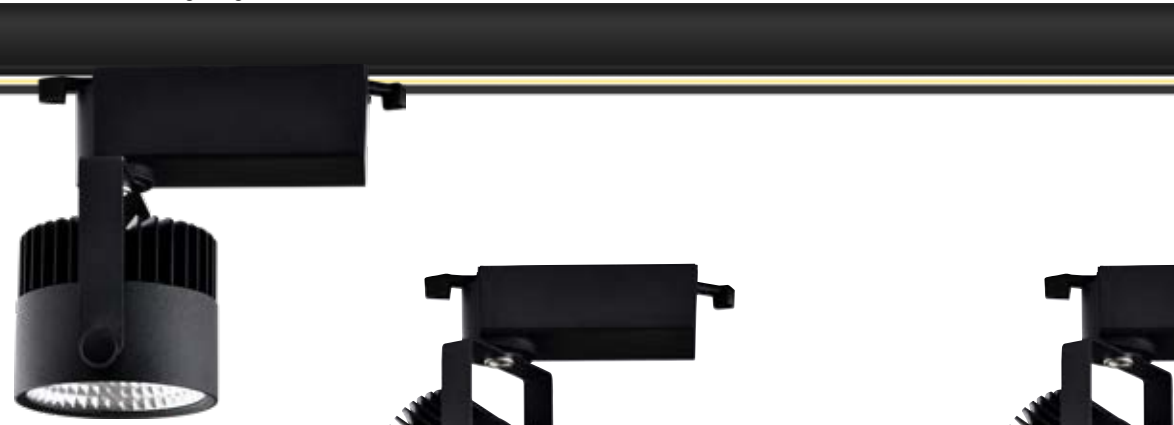

JBR 20381



JBR 20382



JBR 20383



JBR 20384



Dimensions

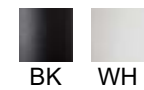
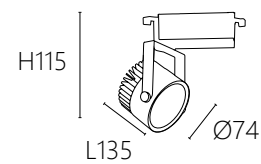
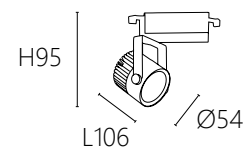

Item No.	Chip	Watts	C.C.T	CRI	Lumens	Size (mm)	▲
JBR 20381	PHILIPS	8W	3000K 4000K 6000K	90+	848Lm	Ø54 L106 H95	36°
JBR 20382	PHILIPS	8W	3000K 4000K 6000K	90+	848Lm	Ø54 L106 H95	--
JBR 20383	PHILIPS	12W	3000K 4000K 6000K	90+	1272Lm	Ø74 L135 H115	36°
JBR 20384	PHILIPS	12W	3000K 4000K 6000K	90+	1272Lm	Ø74 L135 H115	--



JBR 20391



JBR 20392



JBR 20393



JBR 20394

Dimensions

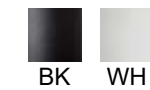
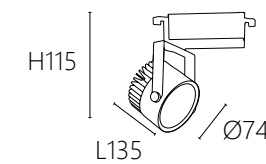
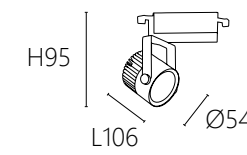

Item No.	Chip	Watts	C.C.T	CRI	Lumens	Size (mm)	▲
JBR 20391	PHILIPS	8W	3000K 4000K 6000K	90+	848Lm	Ø54 L106 H95	36°
JBR 20392	PHILIPS	8W	3000K 4000K 6000K	90+	848Lm	Ø54 L106 H95	--
JBR 20393	PHILIPS	12W	3000K 4000K 6000K	90+	1272Lm	Ø74 L135 H115	36°
JBR 20394	PHILIPS	12W	3000K 4000K 6000K	90+	1272Lm	Ø74 L135 H115	--

TRACK LIGHT

led commercial lighting series



JBR 20411

JBR 20412

JBR 20413

JBR 20414

Dimensions

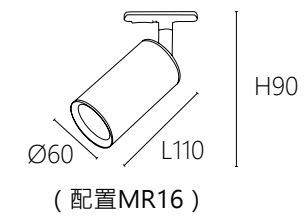

Item No.	Chip	Watts	C.C.T	CRI	Lumens	Size (mm)	▲
JBR 20411	PHILIPS	6W	3000K 4000K 6000K	90+	636Lm	Ø60 L110 H90	25°
JBR 20412	PHILIPS	6W	3000K 4000K 6000K	90+	636Lm	Ø60 L110 H90	25°
JBR 20413	PHILIPS	6W	3000K 4000K 6000K	90+	636Lm	Ø60 L110 H90	25°
JBR 20414	PHILIPS	6W	3000K 4000K 6000K	90+	636Lm	Ø60 L110 H90	25°

TRACK LIGHT

led commercial lighting series



JBR 20421W
(配置MR16)

JBR 20421B
(配置MR16)



JBR 20422W

JBR 20422B

Dimensions

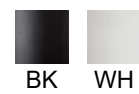
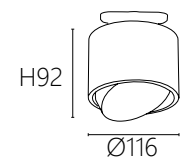
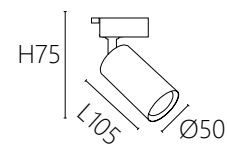

Item No.	Chip	Watts	C.C.T	CRI	Lumens	Size (mm)	▲
JBR 20421B/W	PHILIPS	6W	3000K 4000K 6000K	90+	636Lm	Ø50 L105 H75	25°
JBR 20422B/W	OSRAM	12W	3000K 4000K 6000K	80+	1296Lm	Ø116 H92	--



JBR 20431B/W



JBR 20432B/W

Dimensions

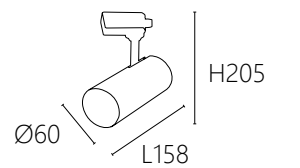
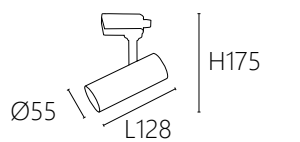

Item No.	Chip	Watts	C.C.T	CRI	Lumens	Size (mm)	▲
JBR 20431B/W	PHILIPS	10W	3000K 4000K 6000K	90+	1060Lm	Ø55 H175	36°
JBR 20432B/W	PHILIPS	18W	3000K 4000K 6000K	90+	1980Lm	Ø60 H205	36°

TRACK LIGHT

led commercial lighting series



Dimensions

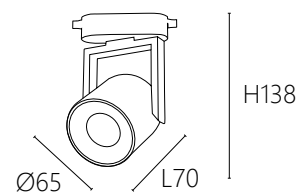

JBR 20441



JBR 20442

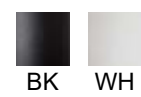

Item No.	Chip	Watts	C.C.T	CRI	Lumens	Size (mm)	▲
JBR 20441	PHILIPS	8W	3000K 4000K 6000K	90+	848Lm	Ø65 L70 H138	36°
JBR 20442	PHILIPS	8W	3000K 4000K 6000K	90+	848Lm	Ø65 L70 H138	36°



Dimensions

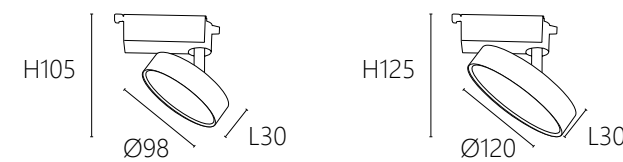

JBR 20451B/W



JBR 20452B/W



Item No.	Chip	Watts	C.C.T	CRI	Lumens	Size (mm)
JBR 20451B/W	OSRAM	8W	3000K 4000K 6000K	80+	846Lm	Ø98 L30 H105
JBR 20452B/W	OSRAM	12W	3000K 4000K 6000K	80+	1926Lm	Ø120 L30 H125

TRACK LIGHT

led commercial lighting series



Dimensions

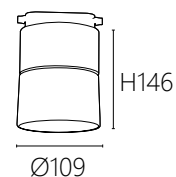
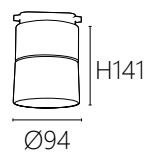

JBR 20461B/W



JBR 20462B/W

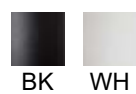

Item No.	Chip	Watts	C.C.T	CRI	Lumens	Size (mm)	▲
JBR 20461B/W	PHILIPS	12W	3000K 4000K 6000K	90+	1272Lm	Ø94 H141mm	30°
JBR 20462B/W	PHILIPS	20W	3000K 4000K 6000K	90+	2120Lm	Ø109 H146mm	30°

Dimensions



Item No.	Chip	Watts	C.C.T	CRI	Lumens	Size (mm)	▲
JBR 20471B	PHILIPS	30W	3000K 4000K 6000K	90+	3180Lm	Ø93 L130 H240	38°
JBR 20471W	PHILIPS	30W	3000K 4000K 6000K	90+	3180Lm	Ø93 L130 H240	38°

配置PHILIPS變壓器

TRACK LIGHT

led commercial lighting series



Dimensions

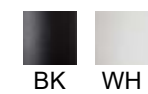
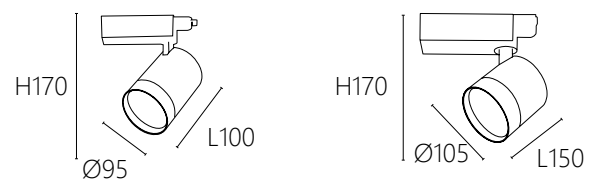

JBR 20481B/W

JBR 20482B/W

Item No.	Chip	Watts	C.C.T	CRI	Lumens	Size (mm)	▲
JBR 20481B/W	PHILIPS	20W	3000K 4000K 6000K	90+	2120Lm	Ø95 L100 H170	24°/ 38°
JBR 20482B/W	PHILIPS	35W	3000K 4000K 6000K	90+	3710Lm	Ø105 L150 H170	24°/ 38°

JBR 20482B/W 配置PHILIPS變壓器

Dimensions

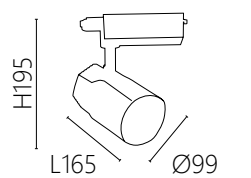

Item No.	Chip	Watts	C.C.T	CRI	Lumens	Size (mm)	▲
JBR 20491	PHILIPS	40W	3000K 4000K 6000K	90+	4240Lm	Ø99 L165 H195	40°
JBR 20492	PHILIPS	40W	3000K 4000K 6000K	90+	4240Lm	Ø99 L165 H195	40°

配置PHILIPS變壓器

DOWN LIGHT

led commercial lighting series

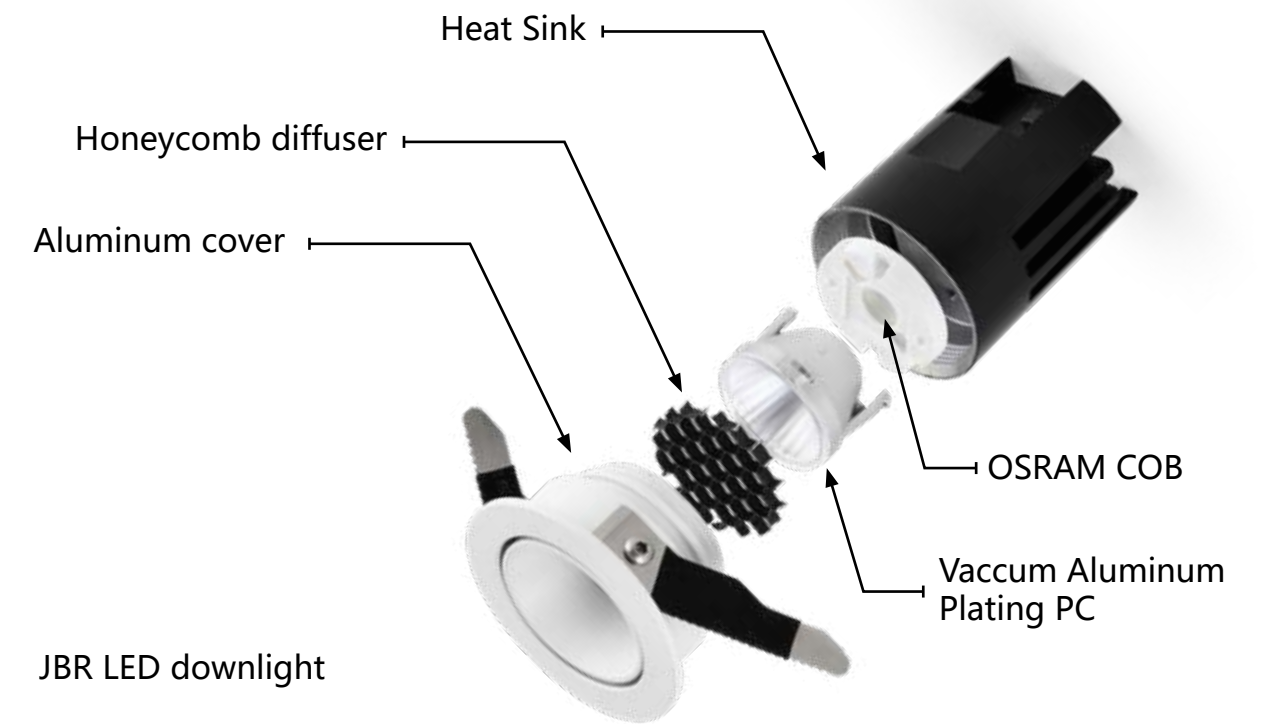

JBR LED downlight

Dimensions

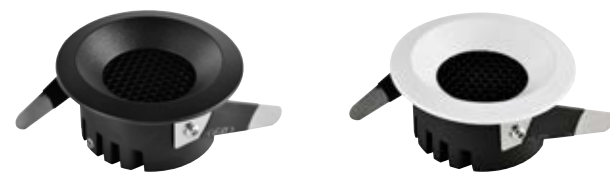
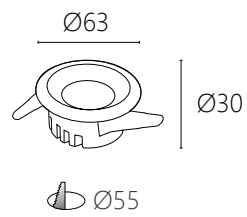

JBR 20501

JBR 20501

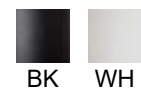

Item No.	Chip	Watts	C.C.T	CRI	Lumens		Size (mm)	
JBR 20501	PHILIPS	6W	3000K 4000K 6000K	90+	636Lm	Ø55	Ø76 H84	36°
JBR 20502	PHILIPS	6W	3000K 4000K 6000K	90+	636Lm	Ø55	Ø76 H84	36°

Dimensions



JBR 20511

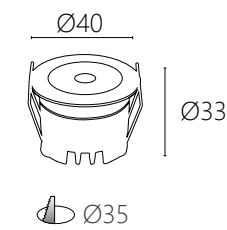

JBR 20512

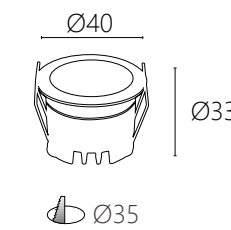

JBR 20513

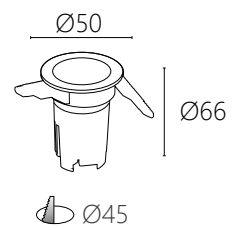

Item No.	Chip	Watts	C.C.T	CRI	Lumens		Size (mm)	
JBR 20511	OSRAM	3W	3000K 4000K	80+	324Lm	Ø35	Ø40 H33	25°
JBR 20512	OSRAM	3W	3000K 4000K	80+	324Lm	Ø35	Ø40 H33	25°
JBR 20513	PHILIPS	6W	3000K 4000K 6000K	90+	636Lm	Ø45	Ø50 H66	24°

SPOT LIGHT

led commercial lighting series



JBR 20521



JBR 20522

Dimensions

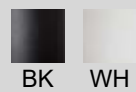
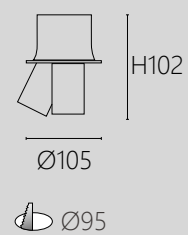

Item No.	Chip	Watts	C.C.T	CRI	Lumens		Size (mm)	
JBR 20521	PHILIPS	10W	3000K 4000K 6000K	90+	1060Lm	Ø95	Ø105 H102	38°
JBR 20522	PHILIPS	10W	3000K 4000K 6000K	90+	1060Lm	Ø95	Ø105 H102	38°



JBR 20531



JBR 20532

Dimensions

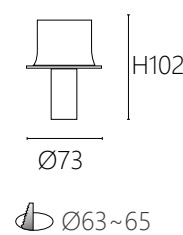

Item No.	Chip	Watts	C.C.T	CRI	Lumens		Size (mm)	
JBR 20531	PHILIPS	5W	3000K 4000K 6000K	90+	530Lm	Ø63~65	Ø73 H102	38°
JBR 20532	PHILIPS	5W	3000K 4000K 6000K	90+	530Lm	Ø63~65	Ø73 H102	38°

SPOT LIGHT

led commercial lighting series

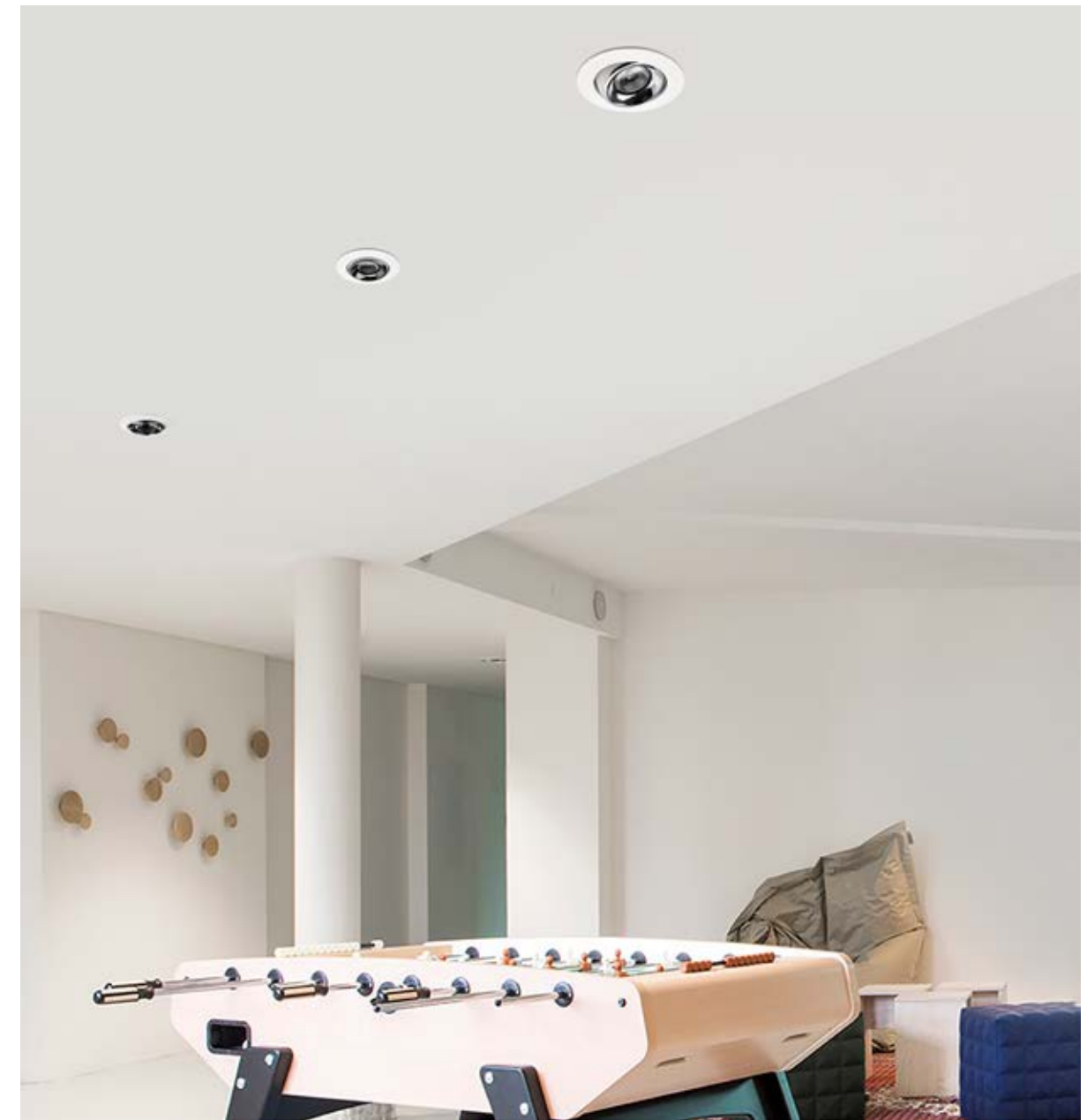

Dimensions

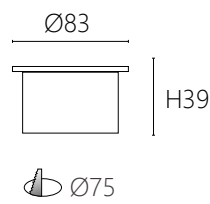

JBR 20541



JBR 20542

Item No.	Chip	Watts	C.C.T	CRI	Lumens		Size (mm)	
JBR 20541	三安	8W	3000K 4000K	80+	880Lm	Ø75	Ø83 H39mm	24°
JBR 20542	三安	8W	3000K 4000K	80+	808Lm	Ø75	Ø83 H39mm	24°

Dimensions

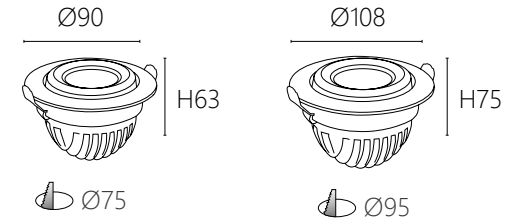

JBR 20551

JBR 20552

Item No.	Chip	Watts	C.C.T	CRI	Lumens		Size (mm)	
JBR 20551	PHILIPS	8W	3000K 4000K 6000K	90+	848Lm	Ø75	Ø90 H63	38°
JBR 20552	PHILIPS	12W	3000K 4000K 6000K	90+	1272Lm	Ø95	Ø108 H75	38°

DOWN LIGHT

led commercial lighting series



JBR 20571



JBR 20572



可訂製 CRI 97

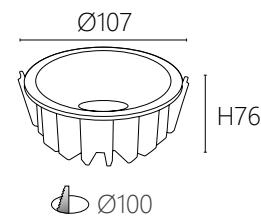
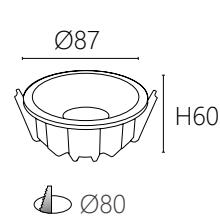

Dimensions



JBR 20561





JBR 20562

Item No.	Chip	Watts	C.C.T	CRI	Lumens		Size (mm)	
JBR 20561	PHILIPS	12W	3000K 4000K 6000K	90+	1272Lm	Ø80	Ø87 H60	24°
JBR 20562	PHILIPS	18W	3000K 4000K 6000K	90+	1908Lm	Ø100	Ø107 H76	24°

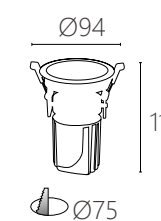
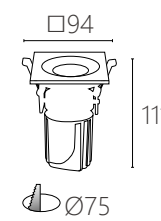
Dimensions



Item No.	Chip	Watts	C.C.T	CRI	Lumens		Size (mm)	
JBR 20571	PHILIPS	12W	3000K 4000K 6000K	90+	1272Lm	Ø75	W94 H111	15~60°
JBR 20572	PHILIPS	12W	3000K 4000K 6000K	90+	1272Lm	Ø75	Ø94 H111	15~60°

SPOT LIGHT

led commercial lighting series



Dimensions

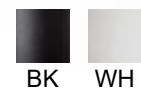

Item No.	Chip	Watts	C.C.T	CRI	Lumens	Ø	Size (mm)	▲
JBR 20581B/W	PHILIPS	6W	3000K 4000K 6000K	90+	636Lm	Ø55	Ø63 H44	24°/ 55°
JBR 20582B/W	PHILIPS	10W	3000K 4000K 6000K	90+	1060Lm	Ø75	Ø85 H52	24°/ 55°

55°為特規產品，恕不退貨



Honeycomb diffuser

Dimensions

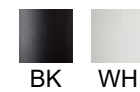
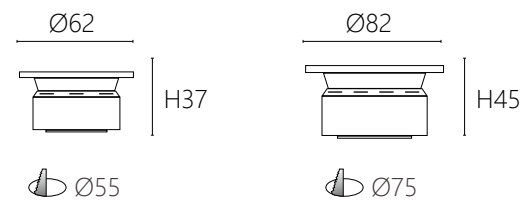

Item No.	Chip	Watts	C.C.T	CRI	Lumens	Ø	Size (mm)	▲
JBR 20591B/W	PHILIPS	6W	3000K 4000K 6000K	90+	636Lm	Ø55	Ø62 H37	36°
JBR 20592B/W	PHILIPS	8W	3000K 4000K 6000K	90+	848Lm	Ø75	Ø82 H45	36°

DOWN LIGHT

led commercial lighting series





JBR 20601 B/W

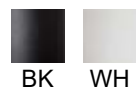
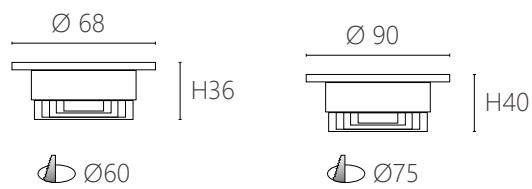

JBR 20602 B/W

Dimensions



Item No.	Chip	Watts	C.C.T	CRI	Lumens		Size (mm)	
JBR 20601B/W	PHILIPS	6W	3000K 4000K 6000K	90+	636Lm	Ø60	Ø68 H36	24°
JBR 20602B/W	PHILIPS	8W	3000K 4000K 6000K	90+	848Lm	Ø75	Ø90 H40	24°





JBR 20611

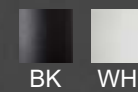

JBR 20612

Dimensions



Item No.	Chip	Watts	C.C.T	CRI	Lumens		Size (mm)	
JBR 20611	PHILIPS	12W	3000K 4000K 6000K	90+	1272Lm	Ø75	Ø86 H73	30°
JBR 20612	PHILIPS	12W	3000K 4000K 6000K	90+	1272Lm	Ø75	Ø86 H73	30°

DOWN LIGHT

led commercial lighting series



JBR 20621 B/W



JBR 20622 B/W

Dimensions

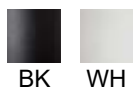
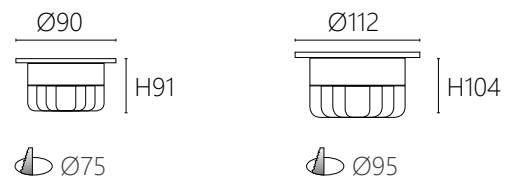

Item No.	Chip	Watts	C.C.T	CRI	Lumens	Ø	Size (mm)
JBR 20621B/W	PHILIPS	10W	3000K 4000K 6000K	90+	1060Lm	Ø75	Ø90 H91
JBR 20622B/W	PHILIPS	16W	3000K 4000K 6000K	90+	1696Lm	Ø95	Ø112 H104

Dimensions



JBR 20631 B/W



JBR 20632 B/W

Item No.	Chip	Watts	C.C.T	CRI	Lumens	Ø	Size (mm)	▲
JBR 20631B/W	PHILIPS	8W	3000K 4000K 6000K	90+	848Lm	Ø75	Ø85 H59	45°
JBR 20632B/W	PHILIPS	15W	3000K 4000K 6000K	90+	1590Lm	Ø95	Ø105 H71	45°

DOWN LIGHT
led commercial lighting series



Dimensions

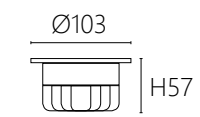

Ø90~95



JBR 20641

JBR 20642

Item No.	Chip	Watts	C.C.T	CRI	Lumens	Ø	Size (mm)	▲
JBR 20641	PHILIPS	12W	3000K 4000K 6000K	90+	1272Lm	Ø90~95	Ø103 H57	45°
JBR 20642	PHILIPS	12W	3000K 4000K 6000K	90+	1272Lm	Ø90~95	Ø103 H57	45°

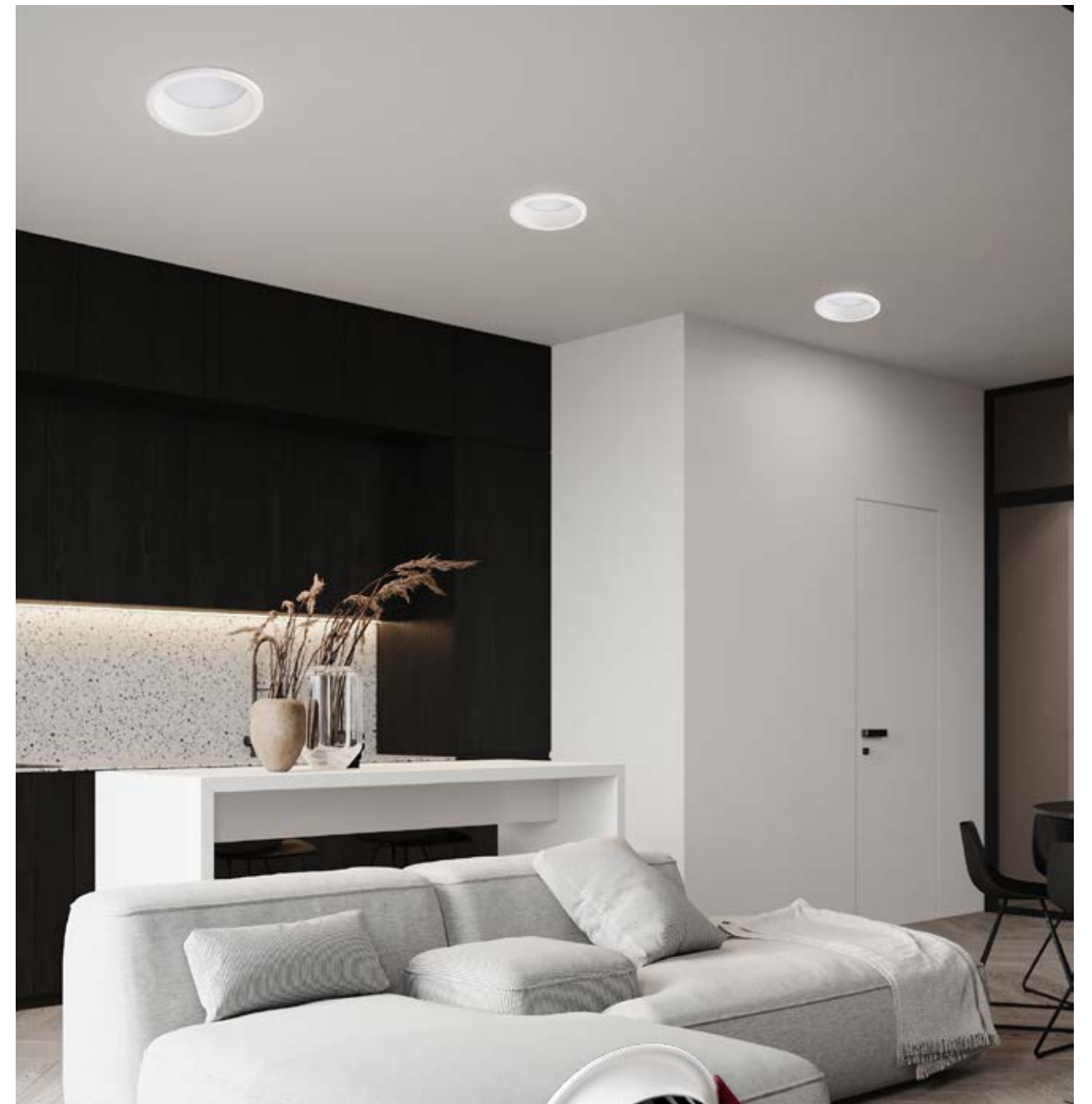

Dimensions

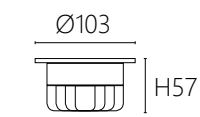

Ø90~95

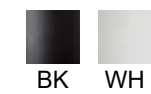

JBR 20651

JBR 20652

Item No.	Chip	Watts	C.C.T	CRI	Lumens	Ø	Size (mm)
JBR 20651	OSRAM	12W	3000K 4000K 6000K	80+	1296Lm	Ø90~95	Ø103 H57
JBR 20652	OSRAM	12W	3000K 4000K 6000K	80+	1296Lm	Ø90~95	Ø103 H57

DOWN LIGHT

led commercial lighting series



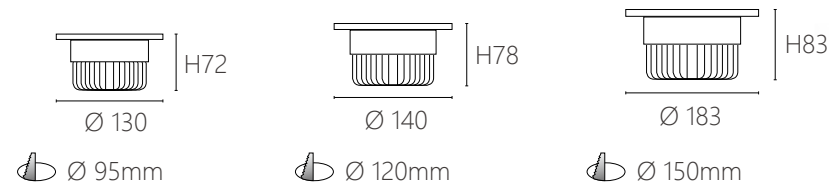

Dimensions

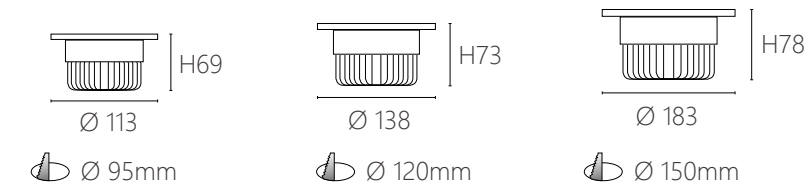

Item No.	Chip	Watts	C.C.T	CRI	Lumens		Size (mm)
JBR 20661	OSRAM	15W	3000K 4000K 6000K	80+	1620Lm	Ø95	Ø130 H72
JBR 20662	OSRAM	20W	3000K 4000K 6000K	80+	2160Lm	Ø120	Ø140 H78
JBR 20663	OSRAM	25W	3000K 4000K 6000K	80+	2700Lm	Ø150	Ø183 H83

Dimensions



Item No.	Chip	Watts	C.C.T	CRI	Lumens		Size (mm)	
JBR 20671	PHILIPS	15W	3000K 4000K 6000K	90+	1590Lm	Ø95	Ø113 H69	36°
JBR 20672	PHILIPS	20W	3000K 4000K 6000K	90+	2120Lm	Ø120	Ø138 H73	36°
JBR 20673	PHILIPS	25W	3000K 4000K 6000K	90+	2650Lm	Ø150	Ø183 H78	36°

DOWN LIGHT

led commercial lighting series



Dimensions

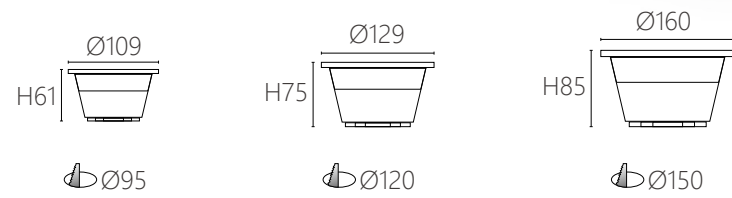

Item No.	Chip	Watts	C.C.T	CRI	Lumens		Size (mm)	▲
JBR 20681	PHILIPS	15W	3000K 4000K 6000K	90+	1590Lm	Ø95	Ø109 H61	50°
JBR 20682	PHILIPS	20W	3000K 4000K 6000K	90+	2120Lm	Ø120	Ø129 H75	50°
JBR 20683	PHILIPS	25W	3000K 4000K 6000K	90+	2650Lm	Ø150	Ø160 H85	50°

Dimensions

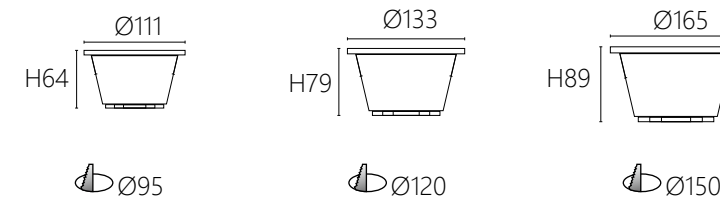

Item No.	Chip	Watts	C.C.T	CRI	Lumens		Size (mm)	▲
JBR 20691	PHILIPS	12W	3000K 4000K 6000K	90+	1272Lm	Ø95	Ø111 H64	55°
JBR 20692	PHILIPS	16W	3000K 4000K 6000K	90+	1696Lm	Ø120	Ø133 H79	55°
JBR 20693	PHILIPS	20W	3000K 4000K 6000K	90+	2240Lm	Ø150	Ø165 H89	55°



DOWN LIGHT

led commercial lighting series



JBR 20701

JBR 20702

JBR 20703

JBR 20704

JBR 20711

JBR 20712

JBR 20713

JBR 20714

Dimensions

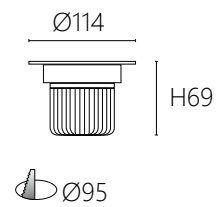
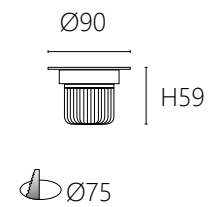
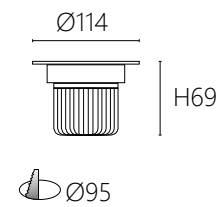
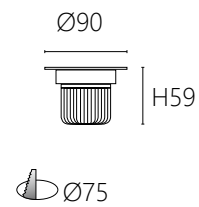

Dimensions

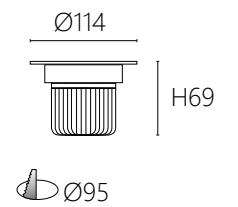
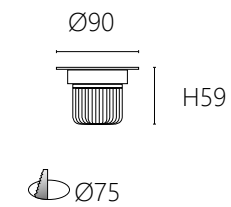
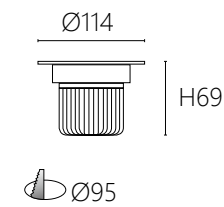
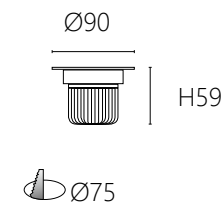

WH

Item No.	Chip	Watts	C.C.T	CRI	Lumens		Size (mm)	
JBR 20701	PHILIPS	8W	3000K 4000K 6000K	90+	848Lm	Ø75	Ø90 H59	36°
JBR 20702	PHILIPS	12W	3000K 4000K 6000K	90+	1060Lm	Ø95	Ø114 H69	36°
JBR 20703	PHILIPS	8W	3000K 4000K 6000K	90+	848Lm	Ø75	Ø90 H59	--
JBR 20704	PHILIPS	12W	3000K 4000K 6000K	90+	1060Lm	Ø95	Ø114 H59	--



BK

Item No.	Chip	Watts	C.C.T	CRI	Lumens		Size (mm)	
JBR 20711	PHILIPS	8W	3000K 4000K 6000K	90+	848Lm	Ø75	Ø90 H59	36°
JBR 20712	PHILIPS	12W	3000K 4000K 6000K	90+	1060Lm	Ø95	Ø114 H69	36°
JBR 20713	PHILIPS	8W	3000K 4000K 6000K	90+	848Lm	Ø75	Ø90 H59	--
JBR 20714	PHILIPS	12W	3000K 4000K 6000K	90+	1060Lm	Ø95	Ø114 H69	--

DOWN LIGHT
led commercial lighting series



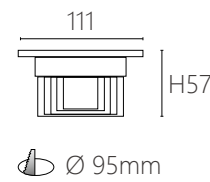

Dimensions

JBR 20721



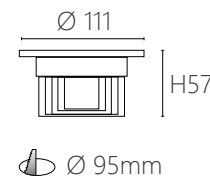

JBR 20722

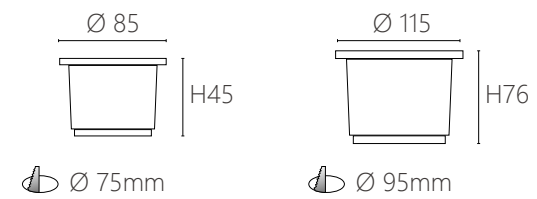

Item No.	Chip	Watts	C.C.T	CRI	Lumens		Size (mm)	
JBR 20721	PHILIPS	10W	3000K 4000K 6000K	90+	1060Lm	Ø95	Ø111 H57	25°
JBR 20722	PHILIPS	10W	3000K 4000K 6000K	90+	1060Lm	Ø95	Ø111 H57	25°

Dimensions



Item No.	Chip	Watts	C.C.T	CRI	Lumens		Size (mm)
JBR 20731	OSRAM	10W	3000K 4000K 6000K	80+	1080Lm	Ø75	Ø85 H45
JBR 20732	OSRAM	15W	3000K 4000K 6000K	80+	1620Lm	Ø95	Ø115 H76

SPOT LIGHT

led commercial lighting series



Dimensions



WH

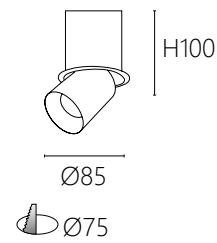

JBR 20741
可訂製 CRI 97

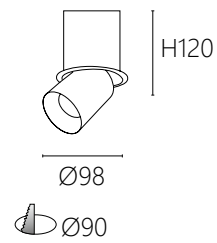

JBR 20742
可訂製 CRI 97

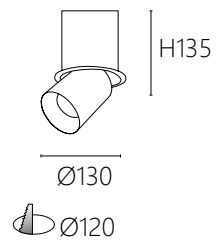

JBR 20743

Item No.	Chip	Watts	C.C.T	CRI	Lumens		Size (mm)	
JBR 20741	PHILIPS	8W	3000K 4000K 6000K	90+	848Lm	Ø75	Ø85 H100	36°
JBR 20742	PHILIPS	12W	3000K 4000K 6000K	90+	1272Lm	Ø90	Ø98 H1120	36°
JBR 20743	PHILIPS	20W	3000K 4000K 6000K	90+	2120Lm	Ø120	Ø130 H135	36°

Dimensions



BK

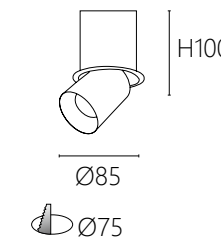

JBR 20751
可訂製 CRI 97

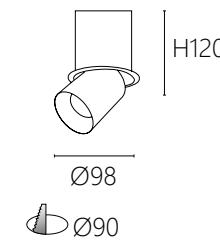

JBR 20752
可訂製 CRI 97

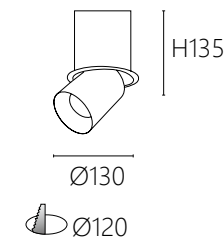

JBR 20753

Item No.	Chip	Watts	C.C.T	CRI	Lumens		Size (mm)	
JBR 20751	PHILIPS	8W	3000K 4000K 6000K	90+	848Lm	Ø75	Ø85 H100	36°
JBR 20752	PHILIPS	12W	3000K 4000K 6000K	90+	1272Lm	Ø90	Ø98 H1120	36°
JBR 20753	PHILIPS	20W	3000K 4000K 6000K	90+	2120Lm	Ø120	Ø130 H135	36°

SPOT LIGHT

led commercial lighting series



Dimensions

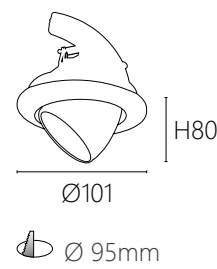

JBR 20761B/W

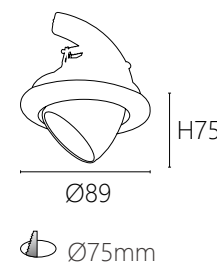

JBR 20762B/W



Item No.	Chip	Watts	C.C.T	CRI	Lumens	⌀	Size (mm)	▲
JBR 20761B/W	PHILIPS	10W	3000K 4000K 6000K	90+	1060Lm	Ø75	Ø89 H75	24°
JBR 20762B/W	PHILIPS	16W	3000K 4000K 6000K	90+	1696Lm	Ø95	Ø101 H80	24°

Dimensions

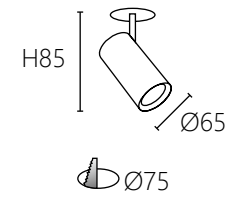

JBR 20771B



Dimensions

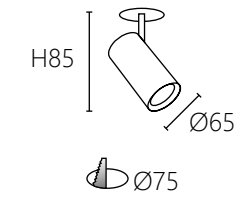

JBR 20771W



Dimensions

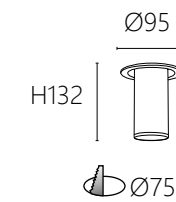

JBR 20772B
(配置MR16)



Dimensions

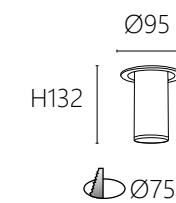

JBR 20772W
(配置MR16)

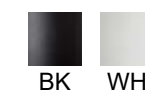

Item No.	Chip	Watts	C.C.T	CRI	Lumens	⌀	Size (mm)	▲
JBR 20771B/W	PHILIPS	10W	3000K 4000K 6000K	90+	1060Lm	Ø75	Ø65 L128 H85	30°
JBR 20772B/W	PHILIPS	6W	3000K 4000K 6000K	90+	636Lm	Ø75	Ø95 H132	25°

Installation steps :

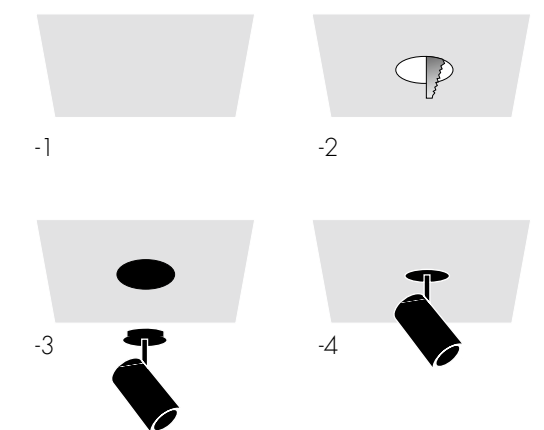

SPOT LIGHT

led commercial lighting series



JBR 20791
 材質：鋁材
 尺寸：Ø82 H49 mm
 嵌孔：Ø75 mm
 (可適用 MR16)



JBR 20792
 材質：鋁材
 尺寸：Ø82 H49 mm
 嵌孔：Ø75 mm
 (可適用 MR16)



JBR 20793
 材質：鋁材
 尺寸：Ø82 H49 mm
 嵌孔：Ø75 mm
 (可適用 MR16)

Dimensions

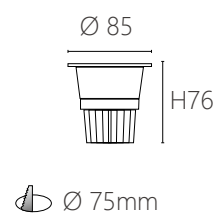

玫瑰金
JBR 20781





鍍鉻
JBR 20782



槍灰色
JBR 20783



黑色
JBR 20784

Item No.	Chip	Watts	C.C.T	CRI	Lumens		Size (mm)	
JBR 20781~4	PHILIPS	12W	3000K 4000K 6000K	90+	1272Lm	Ø75	Ø85 H76	24°



M101
 光源：OSRAM
 尺寸：Ø49 H34mm
 功率：5W
 通光量：540 Lm
 光色：3000K /4000K /6000K
 材質：鋁材
 演色性：CRI>80
 可選黑殼 / 白殼



MR16
 光源：PHILIPS
 尺寸：Ø49 H61mm
 功率：6W
 通光量：636 Lm
 光色：3000K /4000K /6000K
 材質：鋁材
 發光角度：25°
 演色性：CRI>90
 可選槍灰 / 白殼



M65 可訂製 CRI 97
 光源：PHILIPS
 尺寸：Ø50 H65mm
 功率：8W
 通光量：848 Lm
 光色：3000K /4000K /6000K
 材質：壓鑄鋁
 發光角度：24°/36°
 演色性：CRI>90



M90 可訂製 CRI 97
 光源：PHILIPS
 尺寸：Ø50 H90mm
 功率：12W
 通光量：1272 Lm
 光色：3000K /4000K /6000K
 材質：壓鑄鋁
 發光角度：24°/36°
 演色性：CRI>90

DOWN LIGHT

led commercial lighting series

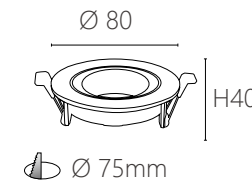

JBR 20811
 材質：鋁材
 尺寸：Ø80 H40 mm
 嵌孔：Ø75 mm
 (可適用 MR16)

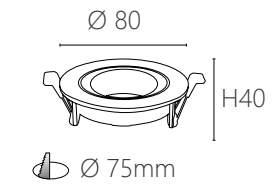

JBR 20812
 材質：鋁材
 尺寸：Ø80 H40 mm
 嵌孔：Ø75 mm
 (可適用 MR16)

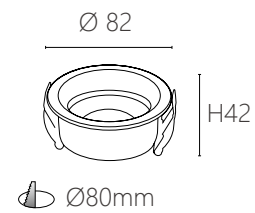

JBR 20801
 材質：鋁材
 尺寸：Ø82 H42 mm
 嵌孔：Ø80 mm
 (可適用 MR16)

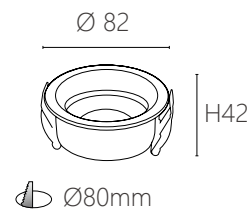

JBR 20802
 材質：鋁材
 尺寸：Ø82 H42 mm
 嵌孔：Ø80 mm
 (可適用 MR16)

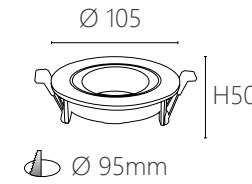

JBR 20813
 材質：鋁材
 尺寸：Ø105 H50 mm
 嵌孔：Ø95 mm
 (可適用 MR16)

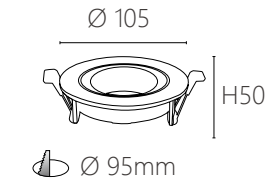

JBR 20814
 材質：鋁材
 尺寸：Ø105 H50 mm
 嵌孔：Ø95 mm
 (可適用 MR16)

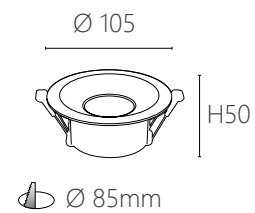

JBR 20803
 材質：鋁材
 尺寸：Ø105 H50 mm
 嵌孔：Ø85 mm
 (可適用 MR16)

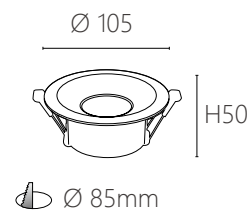

JBR 20804
 材質：鋁材
 尺寸：Ø105 H50 mm
 嵌孔：Ø85 mm
 (可適用 MR16)



M101
 光源：OSRAM
 尺寸：Ø49 H34mm
 功率：5W
 通光量：540 Lm
 光色：3000K /4000K /6000K
 材質：鋁材
 演色性：CRI>80
 可選黑殼 / 白殼



MR16
 光源：PHILIPS
 尺寸：Ø49 H61mm
 功率：6W
 通光量：630 Lm
 光色：3000K /4000K /6000K
 材質：鋁材
 發光角度：25°
 演色性：CRI>90
 可選槍灰 / 白殼



M65 可訂製 CRI 97
 光源：PHILIPS
 尺寸：Ø50 H65mm
 功率：8W
 通光量：848 Lm
 光色：3000K /4000K /6000K
 材質：壓鑄鋁
 發光角度：24°/36°
 演色性：CRI>90



M90 可訂製 CRI 97
 光源：PHILIPS
 尺寸：Ø50 H90mm
 功率：12W
 通光量：1272 Lm
 光色：3000K /4000K /6000K
 材質：壓鑄鋁
 發光角度：24°/36°
 演色性：CRI>90

DOWN LIGHT

led commercial lighting series

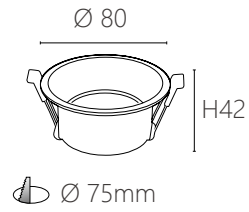

JBR 20821 S
 材質：鋁材
 尺寸：Ø80 H42 mm
 嵌入孔：Ø75 mm
 (可適用 MR16)

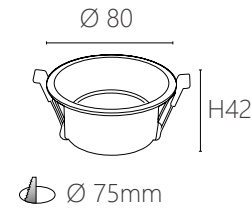

JBR 20822 S
 材質：鋁材
 尺寸：Ø80 H42 mm
 嵌入孔：Ø75 mm
 (可適用 MR16)

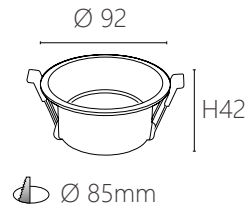

JBR 20821 M
 材質：鋁材
 尺寸：Ø92 H42 mm
 嵌入孔：Ø85 mm
 (可適用 MR16)

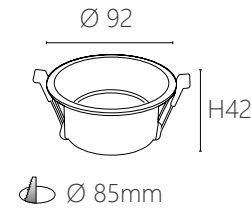

JBR 20822 M
 材質：鋁材
 尺寸：Ø92 H42 mm
 嵌入孔：Ø85 mm
 (可適用 MR16)

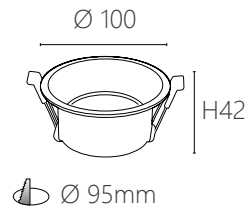

JBR 20821 L
 材質：鋁材
 尺寸：Ø100 H42 mm
 嵌入孔：Ø95 mm
 (可適用 MR16)

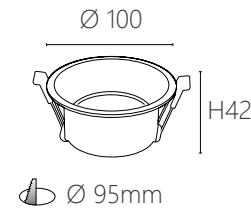

JBR 20822 L
 材質：鋁材
 尺寸：Ø100 H42 mm
 嵌入孔：Ø95 mm
 (可適用 MR16)



旋轉式面蓋
 不易鬆脫 易拆裝
 (取代傳統固定鐵環)



JBR 20831
 材質：鋁材
 尺寸：Ø88 H35 mm
 嵌入孔：Ø75 mm
 (可適用 MR16)



JBR 20832
 材質：鋁材
 尺寸：Ø85 H33 mm
 嵌入孔：Ø75 mm
 (可適用 MR16)



JBR 20833
 材質：鋁材
 尺寸：Ø85 H33 mm
 嵌入孔：Ø75 mm
 (可適用 MR16)



PC diffuser
 可加 PC 罩



M101
 光源：OSRAM
 尺寸：Ø49 H34mm
 功率：5W
 通光量：540 Lm
 光色：3000K / 4000K / 6000K
 材質：鋁材
 演色性：CRI>80
 可選黑殼 / 白殼



MR16
 光源：PHILIPS
 尺寸：Ø49 H61mm
 功率：6W
 通光量：636 Lm
 光色：3000K / 4000K / 6000K
 材質：鋁材
 發光角度：25°
 演色性：CRI>90
 可選槍灰 / 白殼



M65 可訂製 CRI 97
 光源：PHILIPS
 尺寸：Ø50 H65mm
 功率：8W
 通光量：848 Lm
 光色：3000K / 4000K / 6000K
 材質：壓鑄鋁
 發光角度：24°/36°
 演色性：CRI>90



M90 可訂製 CRI 97
 光源：PHILIPS
 尺寸：Ø50 H90mm
 功率：12W
 通光量：1272 Lm
 光色：3000K / 4000K / 6000K
 材質：壓鑄鋁
 發光角度：24°/36°
 演色性：CRI>90

AR-111 DOWN LIGHT

led commercial lighting series

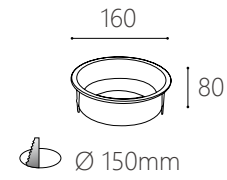

JBR 20841
材質：鋁材
尺寸：Ø160 H80 mm
嵌入孔：Ø150 mm

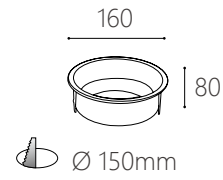

JBR 20842
材質：鋁材
尺寸：Ø160 H80 mm
嵌入孔：Ø150 mm

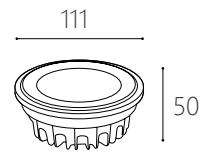

JA 12238 W
光源：**PHILIPS**
尺寸：Ø111 H50mm
功率：12W
通光量：1272 Lm
光色：3000K/ 4000K/ 6000K
材質：鋁材
發光角度：36°
演色性：CRI>90

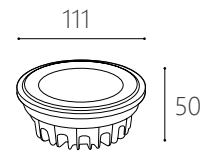

JA 12238 B
光源：**PHILIPS**
尺寸：Ø111 H50mm
功率：12W
通光量：1272 Lm
光色：3000K/ 4000K/ 6000K
材質：鋁材
發光角度：36°
演色性：CRI>90

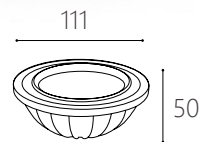

JA 1662 W
光源：**PHILIPS**
尺寸：Ø111 H50mm
功率：16W
通光量：1696 Lm
光色：3000K/ 4000K/ 6000K
材質：壓鑄鋁
發光角度：24°
演色性：CRI>90

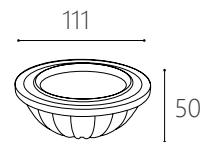

JA 1662 B
光源：**PHILIPS**
尺寸：Ø111 H50mm
功率：16W
通光量：1696 Lm
光色：3000K/ 4000K/ 6000K
材質：壓鑄鋁
發光角度：24°
演色性：CRI>90



Digital Catalogue